



MAAN ALUMINIUM LTD.

CURTAIN WALL

MAAN SEC.-6833

1.751 Kg/Mtr.

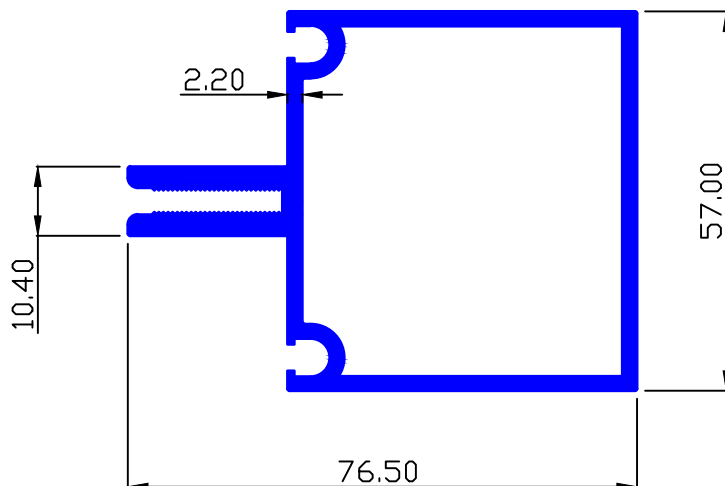

MAAN SEC.-7811

2.165 Kg/Mtr.

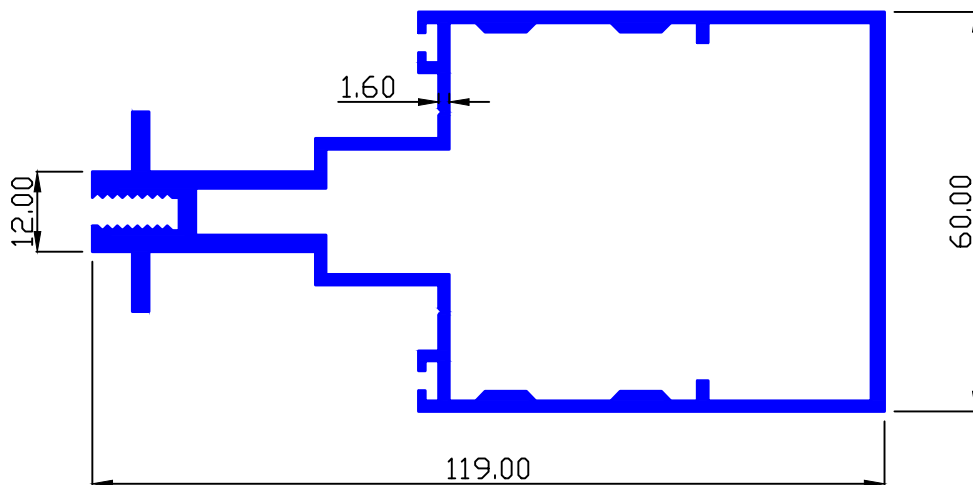

MAAN SEC.-7812

1.593 Kg/Mtr.

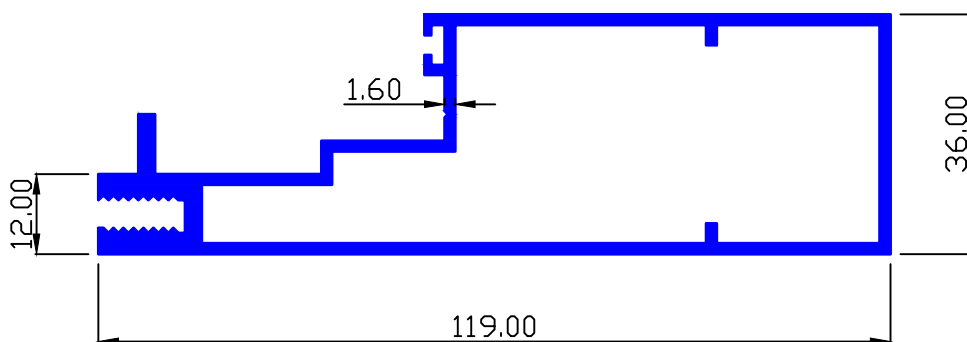



MAAN ALUMINIUM LTD.

CURTAIN WALL

MAAN SEC.-7814

1.574 Kg/Mtr.

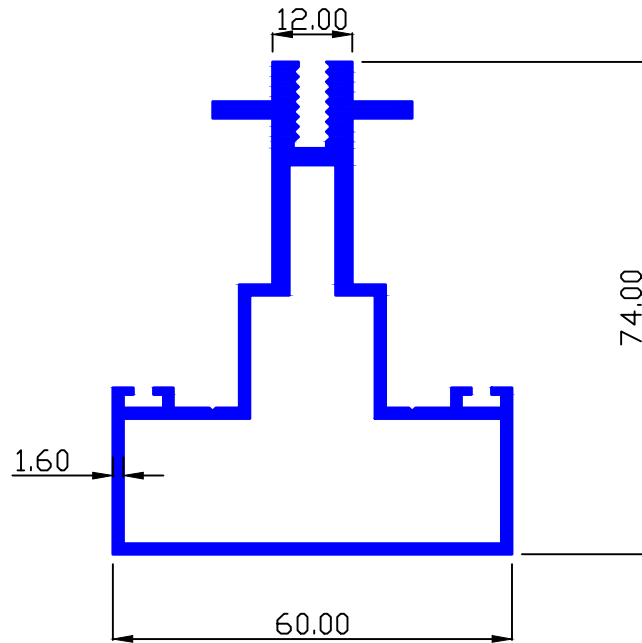

MAAN SEC.-7894

2.799 Kg/Mtr.

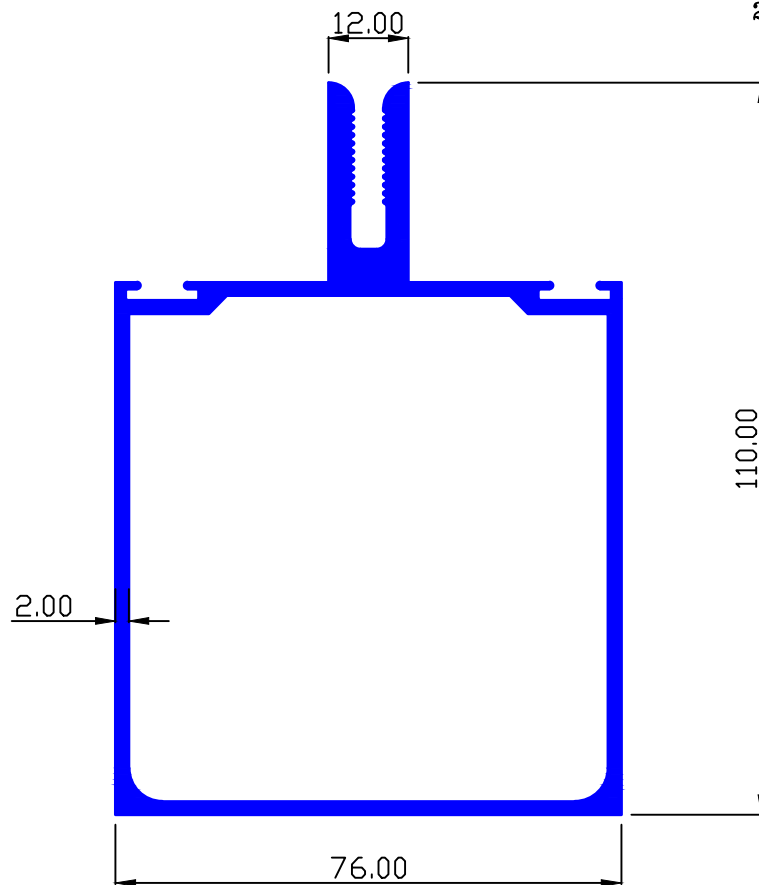



MAAN ALUMINIUM LTD.

CURTAIN WALL

MAAN SEC.-7901

1.990 Kg/Mtr.

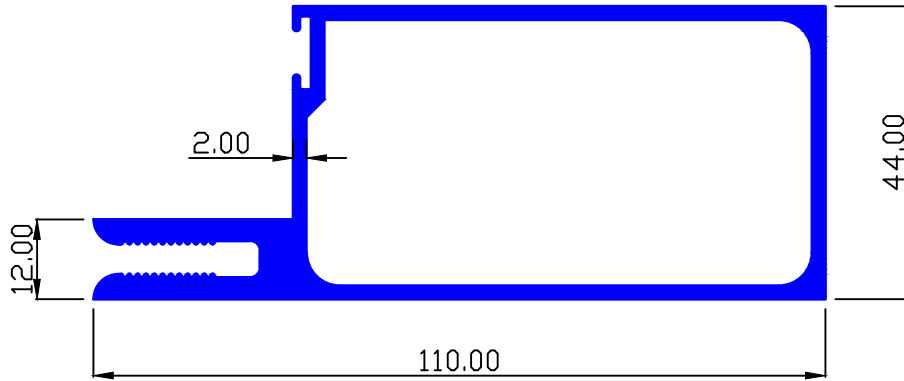

MAAN SEC.-8660

1.877 Kg/Mtr.

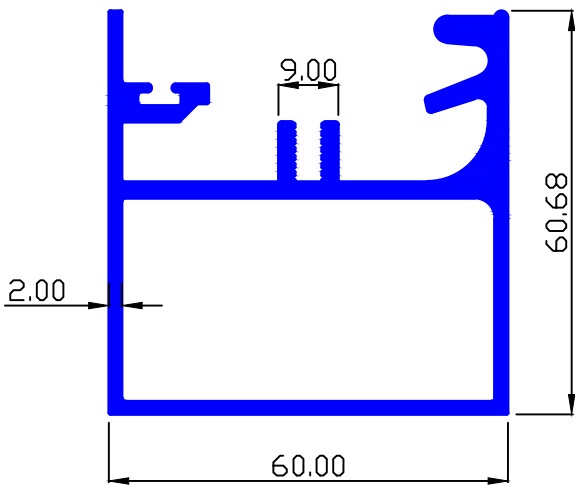

MAAN SEC.-8713

1.336 Kg/Mtr.

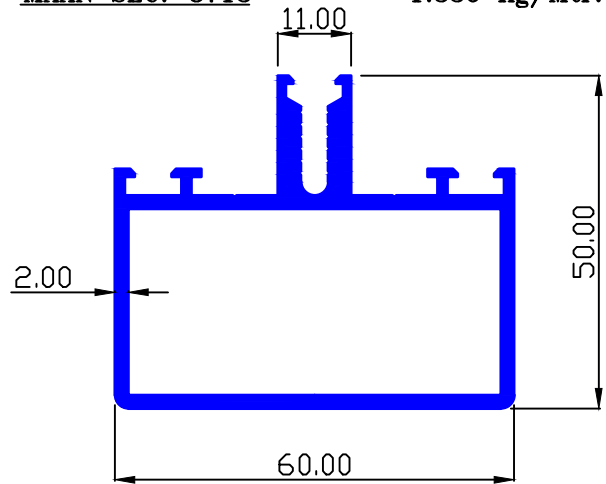

MAAN SEC.-8714

2.673 Kg/Mtr.

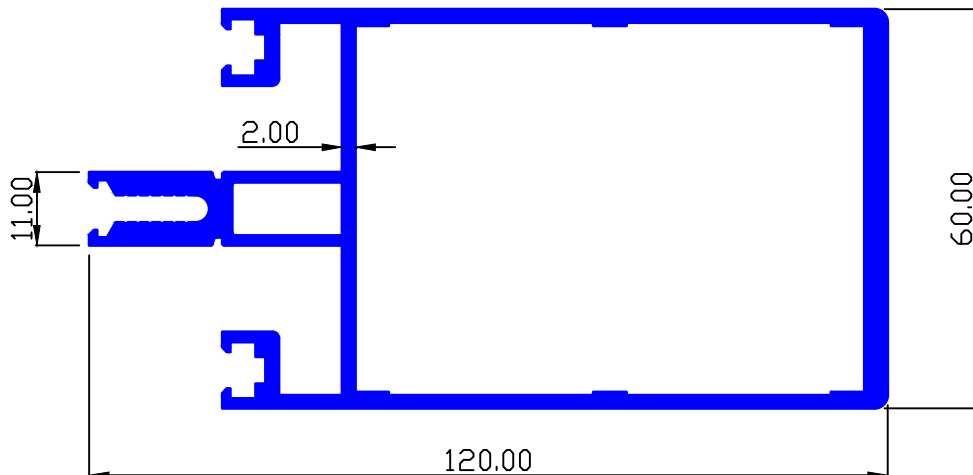



MAAN ALUMINIUM LTD.

CURTAIN WALL

MAAN SEC.-8717

2.218 Kg/Mtr.

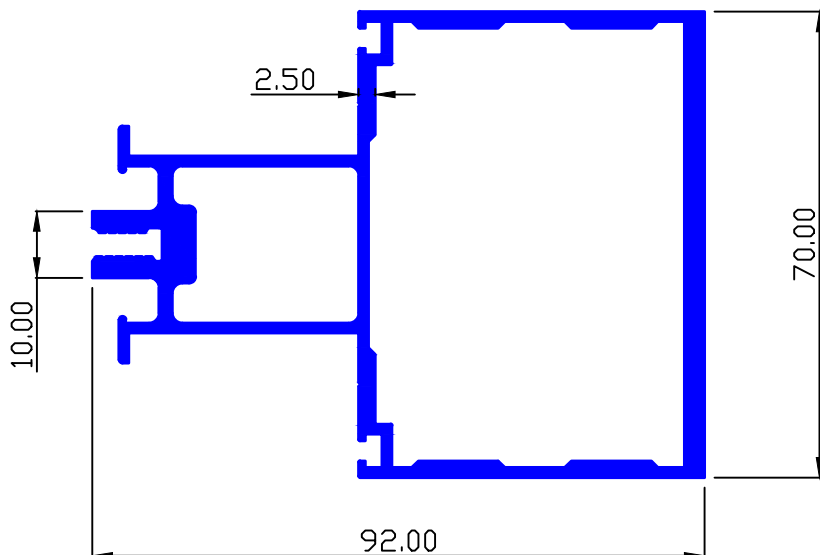

MAAN SEC.-8731

2.106 Kg/Mtr.

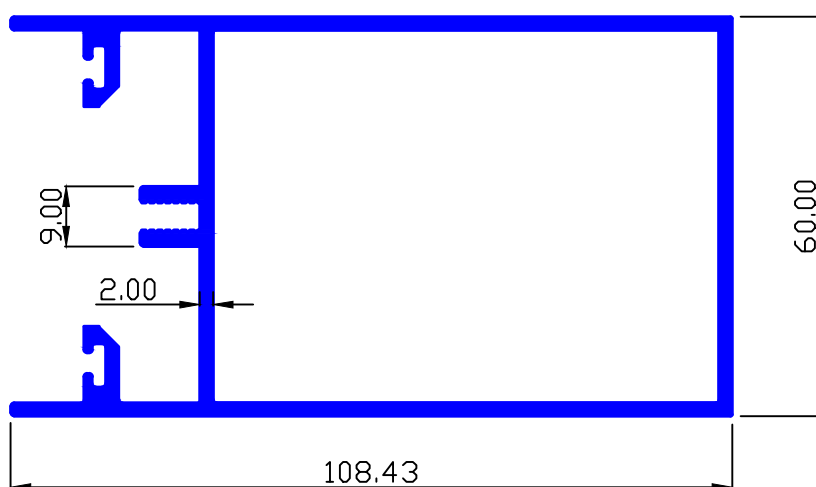

MAAN SEC.-8732

1.747 Kg/Mtr.

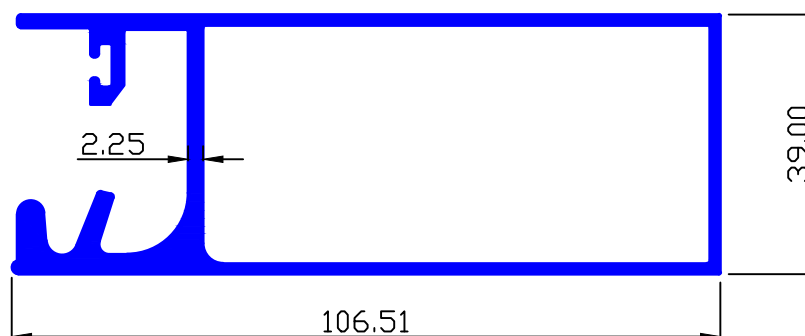



MAAN ALUMINIUM LTD.

CURTAIN WALL

MAAN SEC.-8738

2.004 Kg/Mtr.

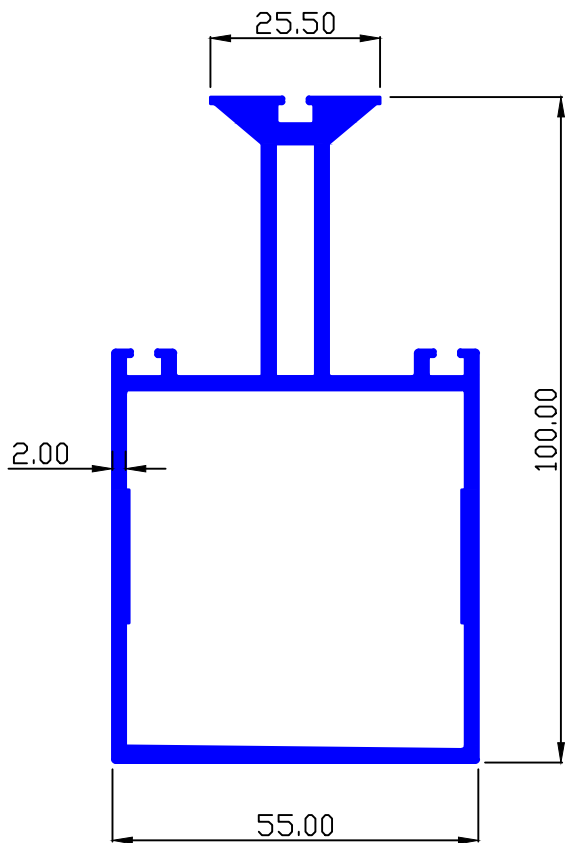

MAAN SEC.-8739

1.621 Kg/Mtr.

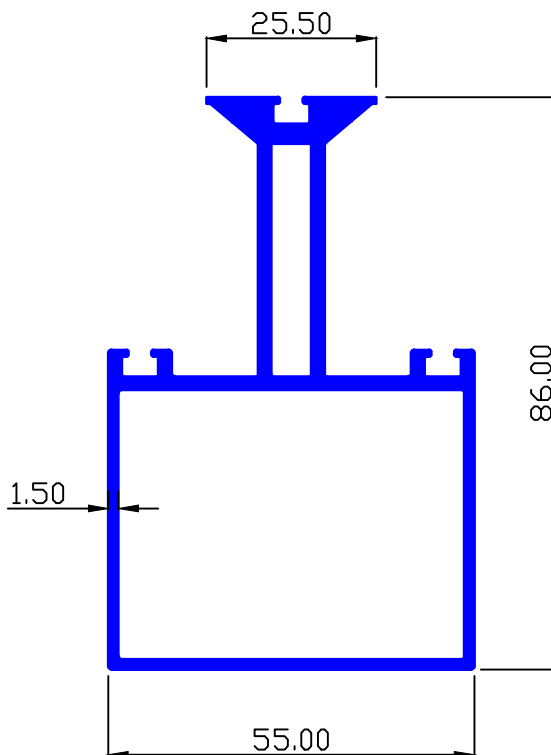

MAAN SEC.-9336

3.413 Kg/Mtr.

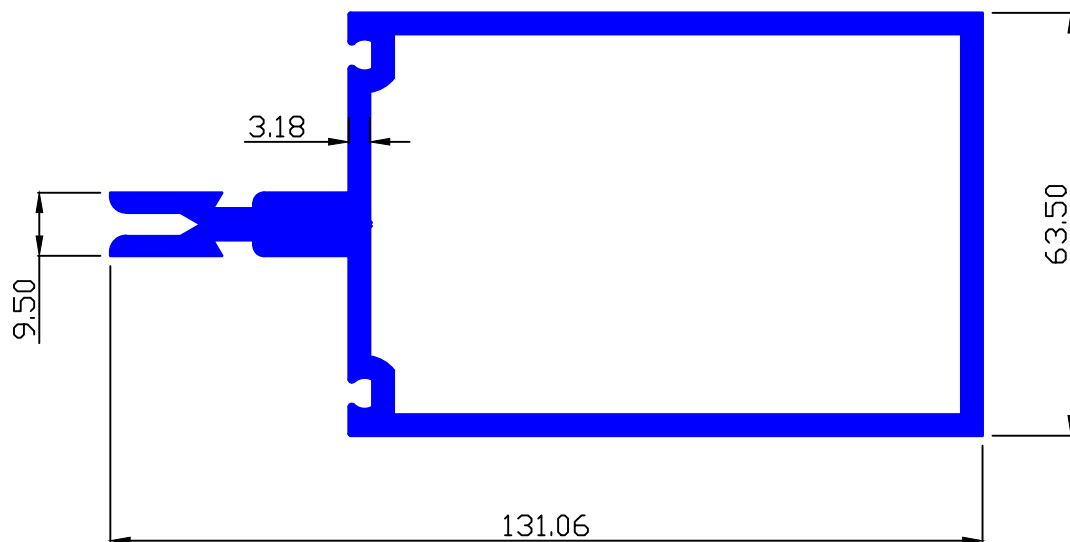



MAAN ALUMINIUM LTD.

CURTAIN WALL

MAAN SEC.-9337

4.149 Kg/Mtr.

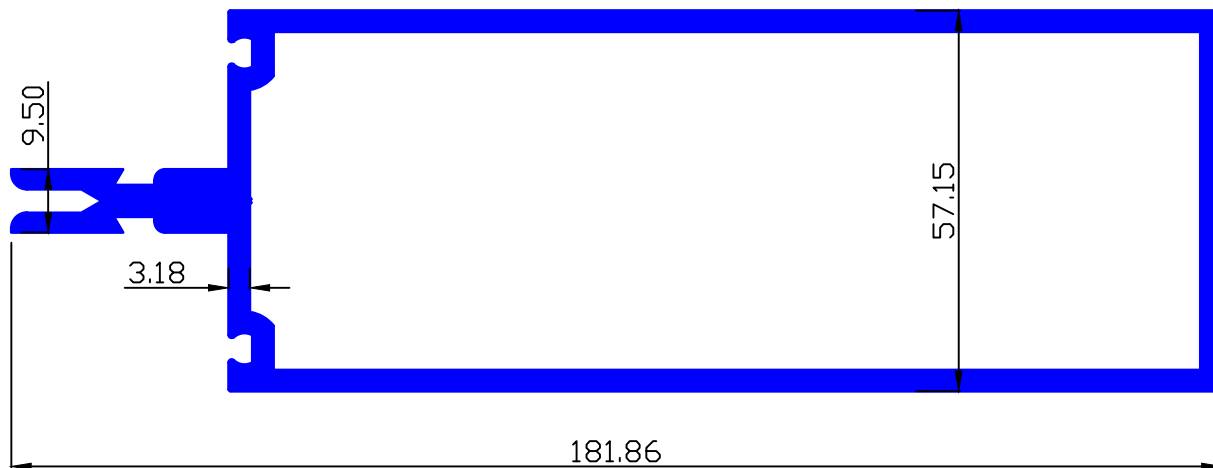

MAAN SEC.-9338

3.713 Kg/Mtr.

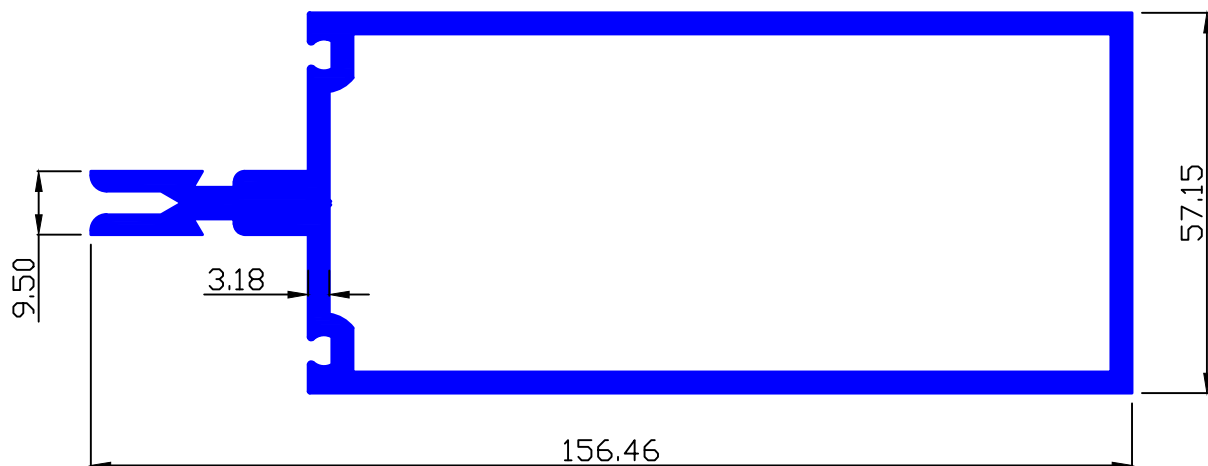

MAAN SEC.-9339

3.958 Kg/Mtr.

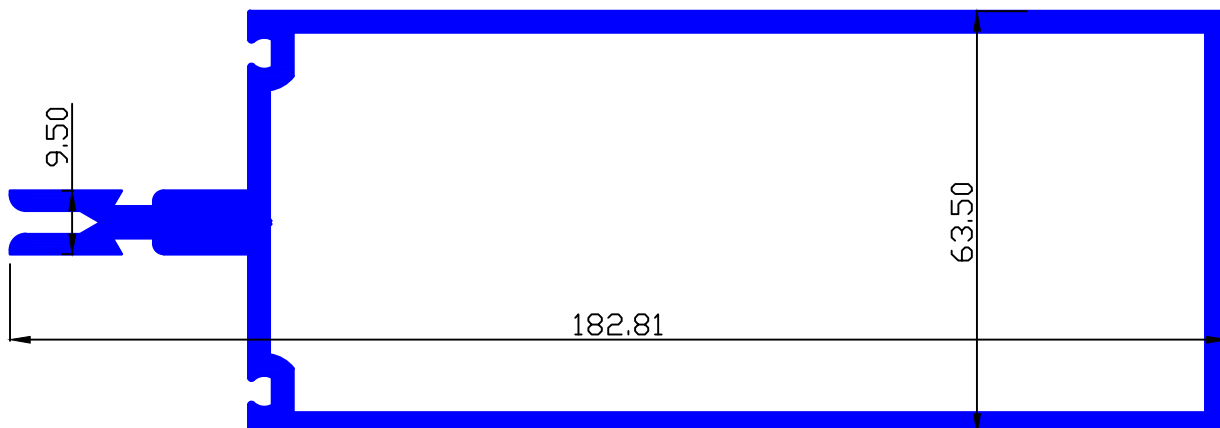



MAAN ALUMINIUM LTD.

CURTAIN WALL

MAAN SEC.-9340

4.067 Kg/Mtr.

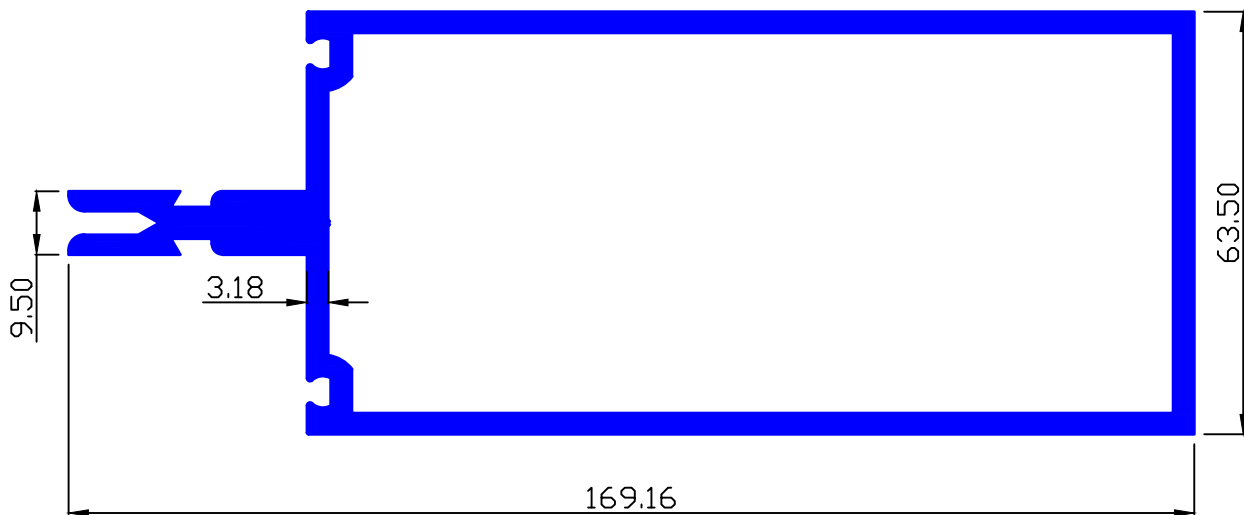

MAAN SEC.-89149

2.623 Kg/Mtr.

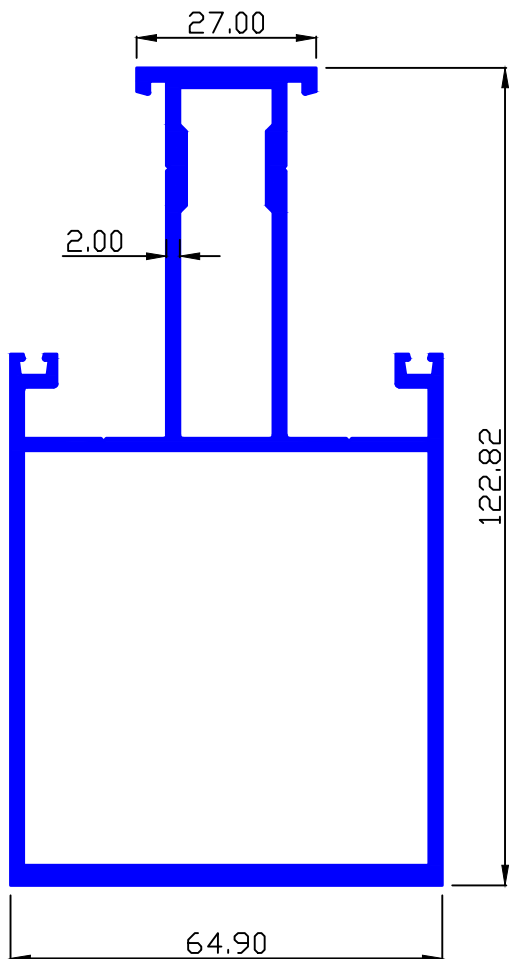

MAAN SEC.-89150

1.853 Kg/Mtr.

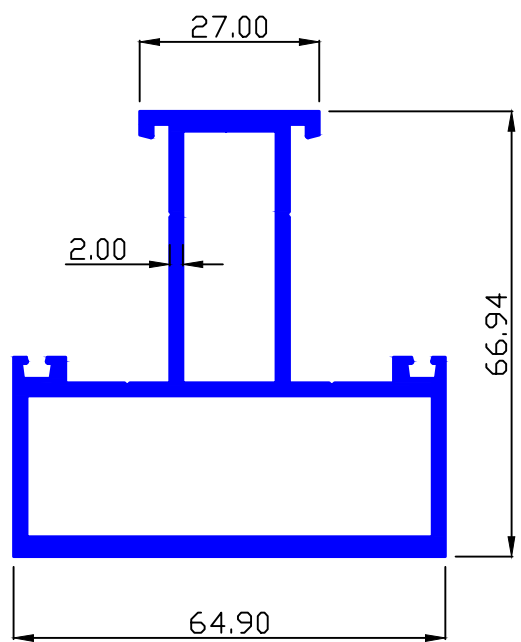



MAAN ALUMINIUM LTD.

CURTAIN WALL

MAAN SEC.-89151

2.457 Kg/Mtr.

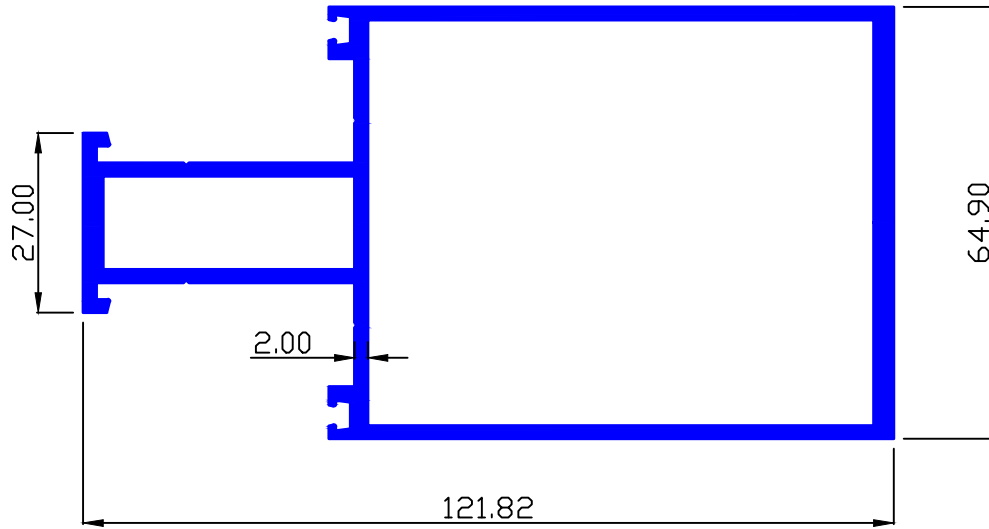

MAAN SEC.-89163

2.930 Kg/Mtr.

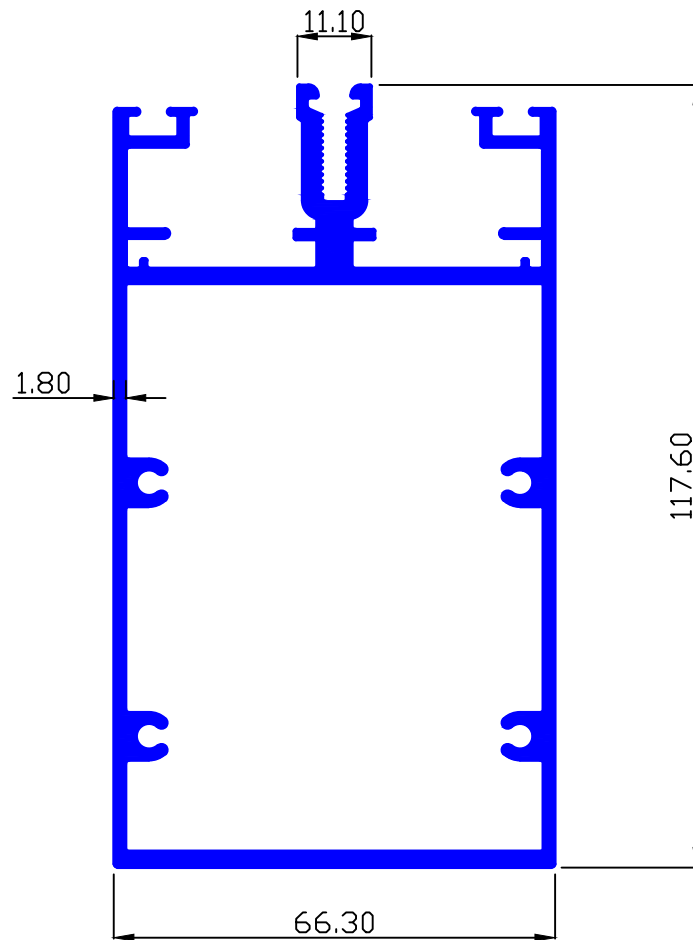



MAAN ALUMINIUM LTD.

CURTAIN WALL

MAAN SEC.-89188

1.495 Kg/Mtr.

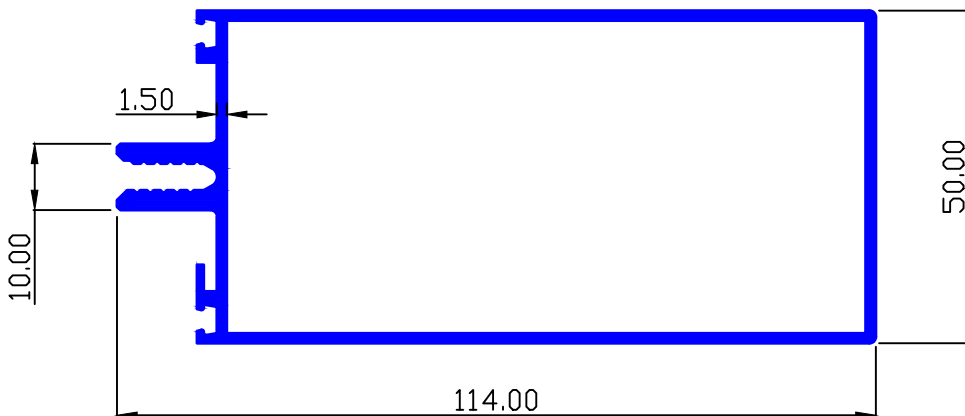

MAAN SEC.-89304

2.685 Kg/Mtr.

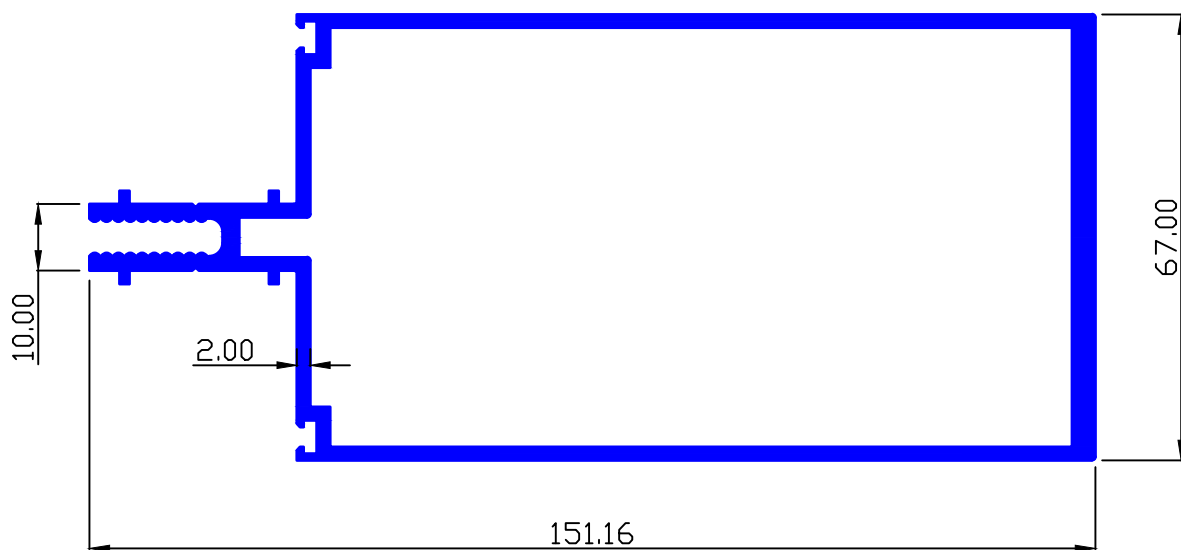

MAAN SEC.-89305

1.405 Kg/Mtr.

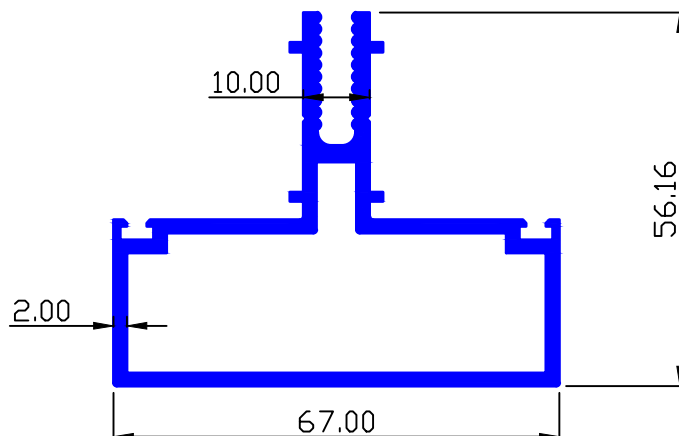



MAAN ALUMINIUM LTD.

CURTAIN WALL

MAAN SEC.-89306

2.110 Kg/Mtr.

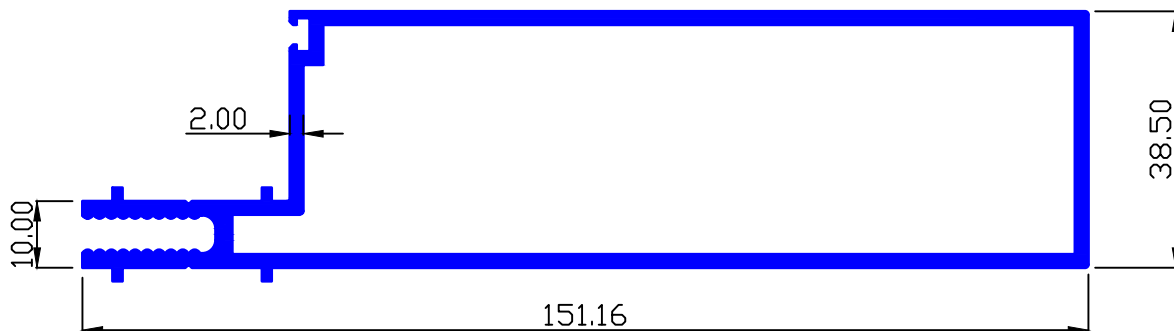

MAAN SEC.-89321

2.704 Kg/Mtr.

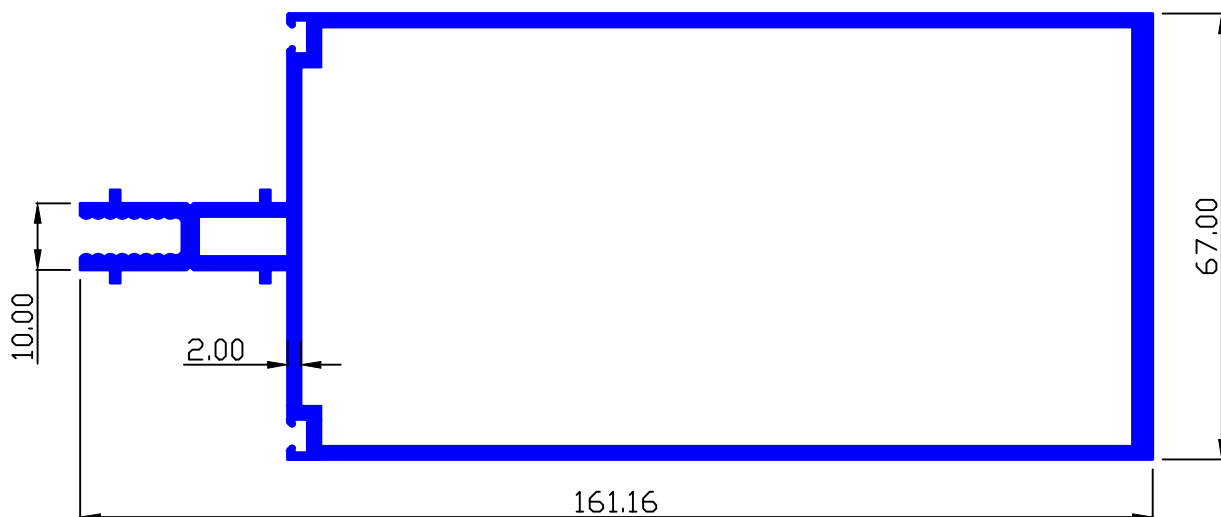

MAAN SEC.-89319

1.689 Kg/Mtr.

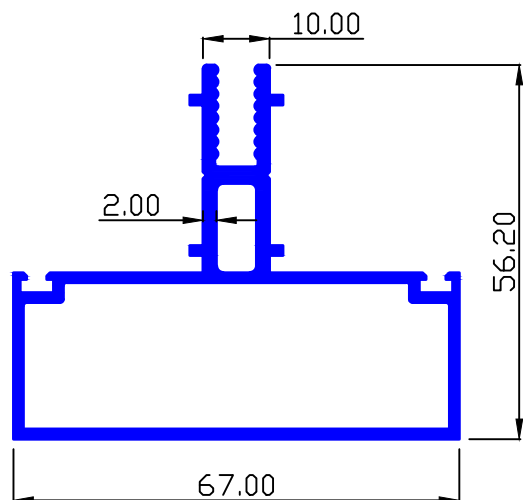

MAAN SEC.-89320

1.165 Kg/Mtr.

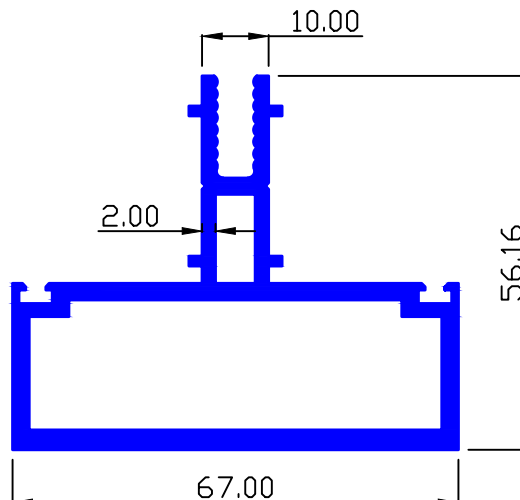



MAAN ALUMINIUM LTD.

CURTAIN WALL

MAAN SEC.-89323

0.925 Kg/Mtr.

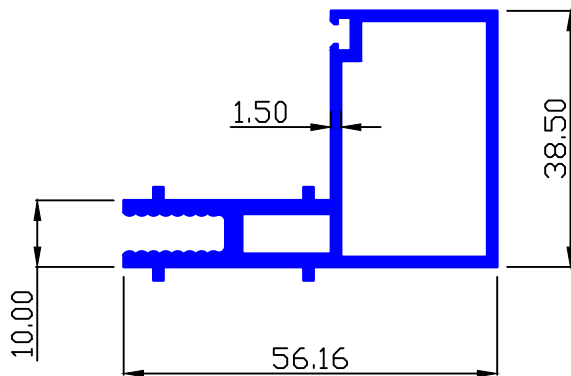

MAAN SEC.-89474

1.778 Kg/Mtr.

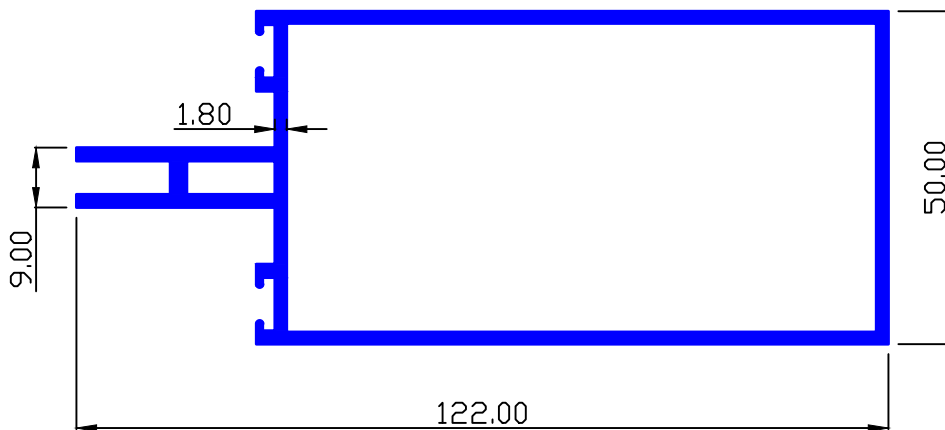

MAAN SEC.-89475

1.632 Kg/Mtr.

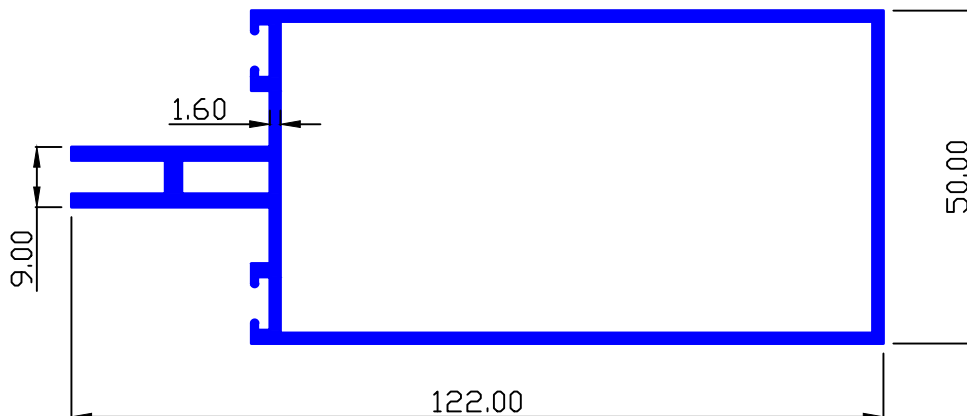



MAAN ALUMINIUM LTD.

CURTAIN WALL

MAAN SEC.-89490

2.808 Kg/Mtr.

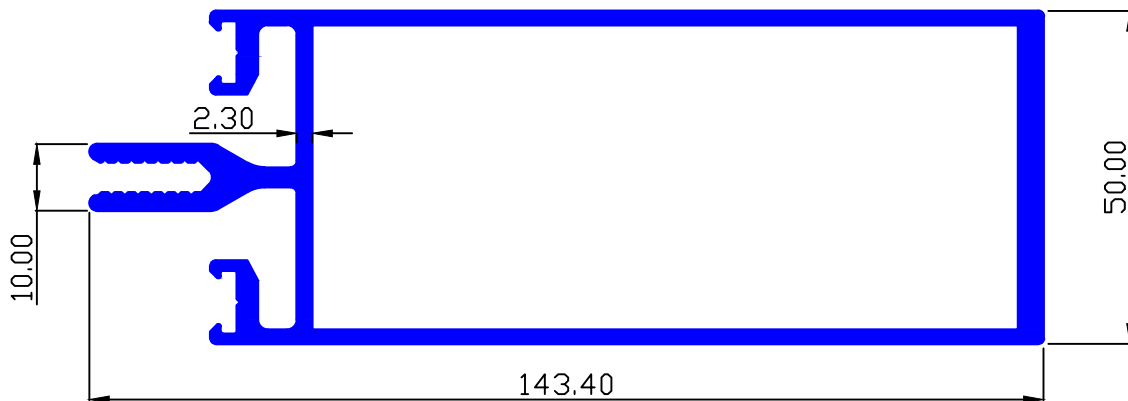

MAAN SEC.-89491

2.357 Kg/Mtr.

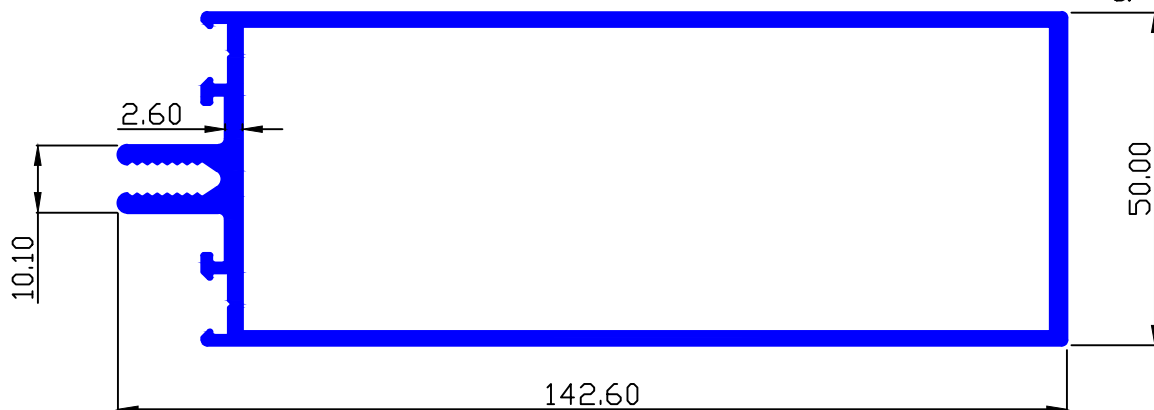

MAAN SEC.-89644

2.00 Kg/Mtr.

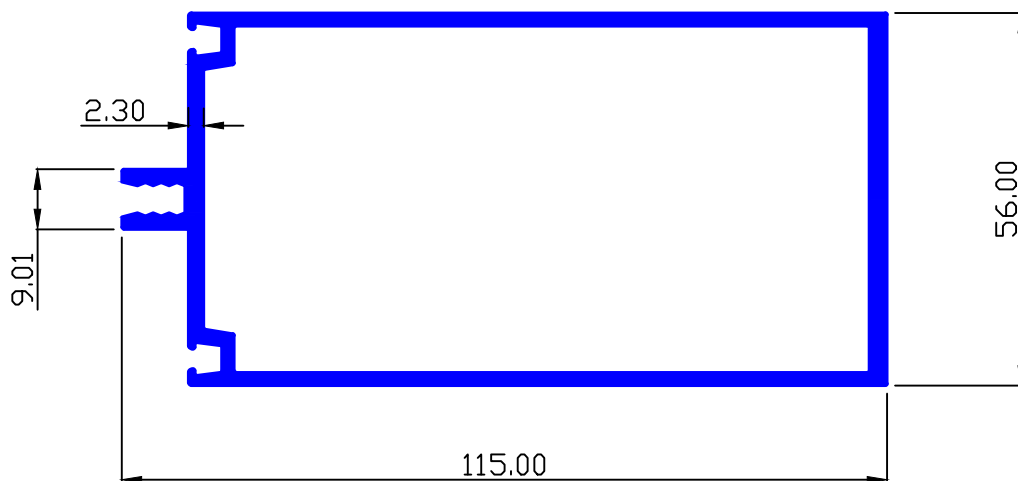



MAAN ALUMINIUM LTD.

CURTAIN WALL

MAAN SEC.-89492

2.357 Kg/Mtr.

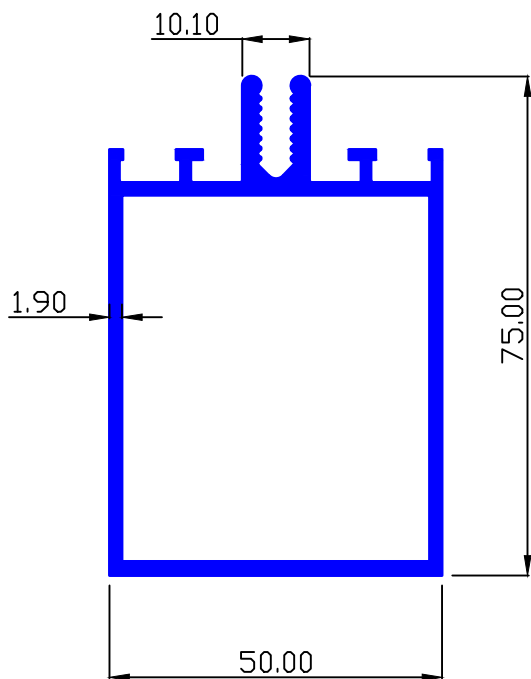

MAAN SEC.-89497

1.658 Kg/Mtr.

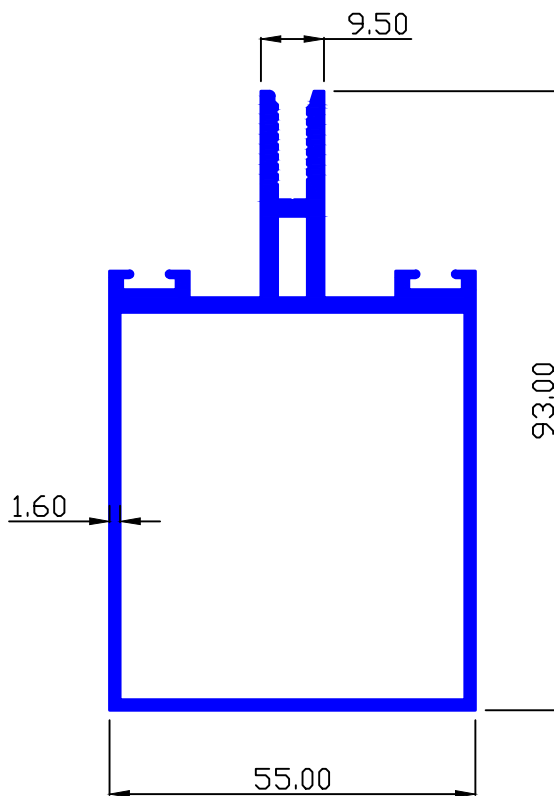

MAAN SEC.-89642

1.408 Kg/Mtr.

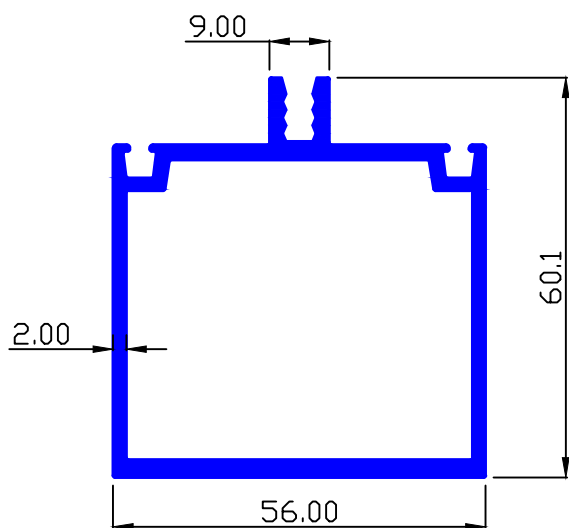

MAAN SEC.-89643

1.192 Kg/Mtr.

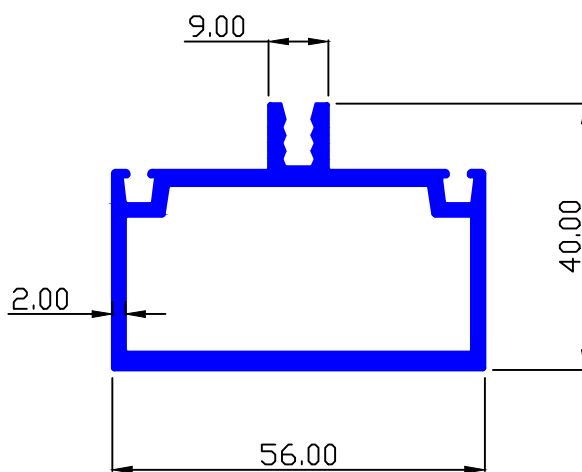



MAAN ALUMINIUM LTD.

CURTAIN WALL

MAAN SEC.-89645

2.256 Kg/Mtr.

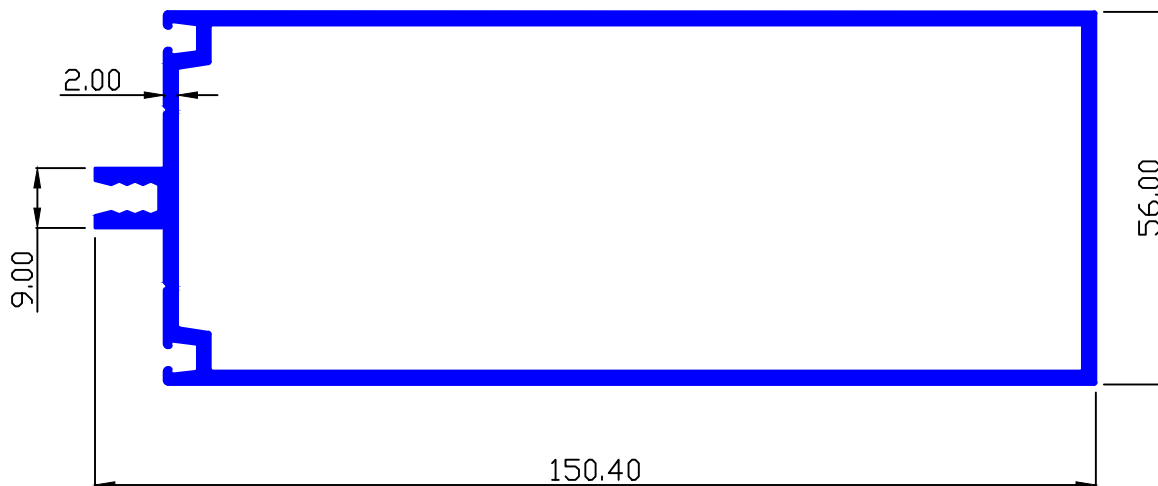

MAAN SEC.-89811

2.531 Kg/Mtr.

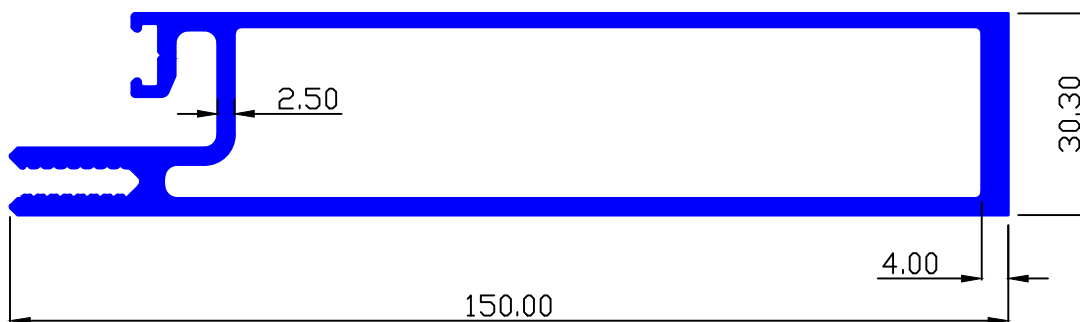

MAAN SEC.-89829

2.889 Kg/Mtr.

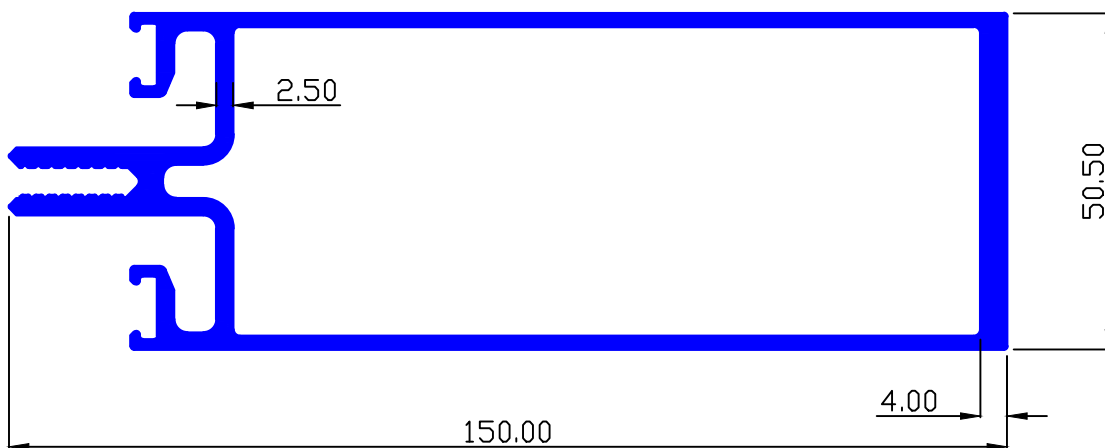



MAAN ALUMINIUM LTD.

CURTAIN WALL

MAAN SEC.-7040

2.725 Kg/Mtr.

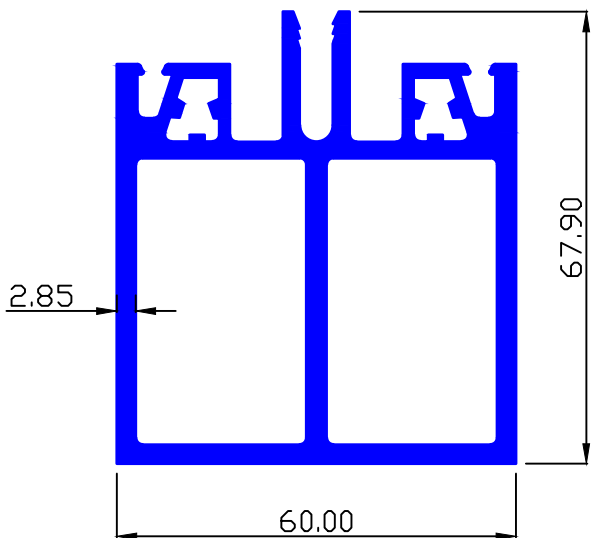

MAAN SEC.-8082

2.235 Kg/Mtr.

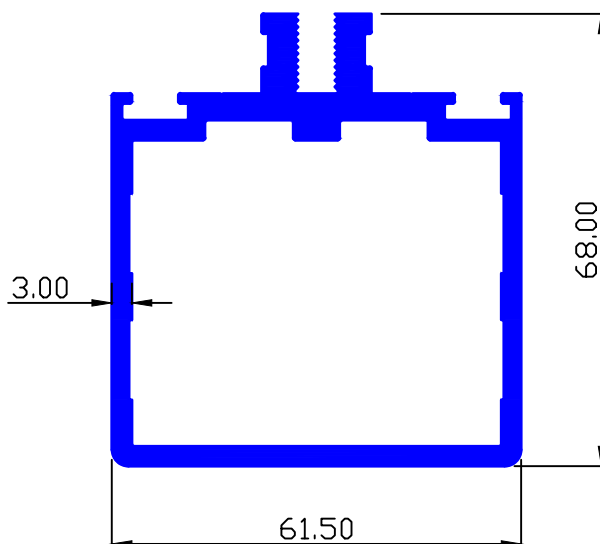

MAAN SEC.-8081

2.995 Kg/Mtr.

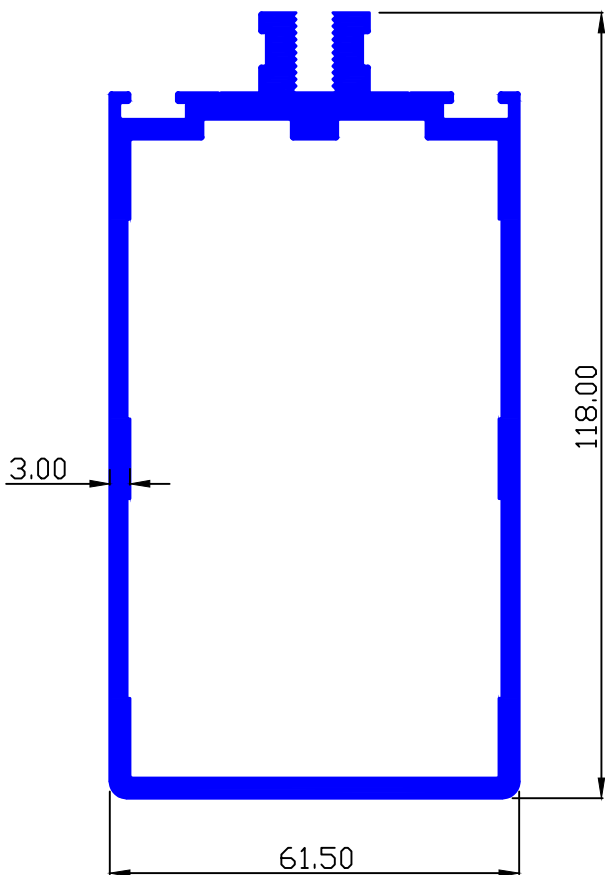

MAAN SEC.-8506

3.000 Kg/Mtr.

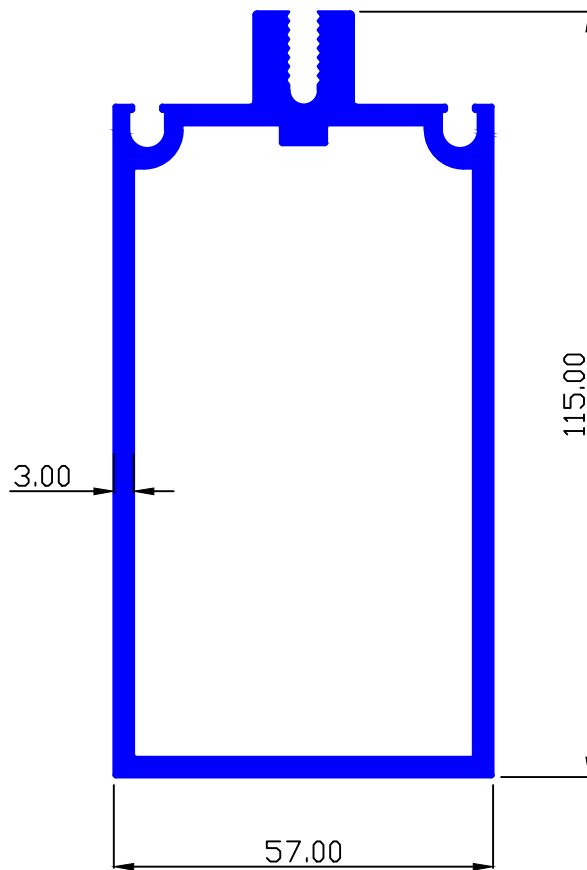



MAAN ALUMINIUM LTD.

CURTAIN WALL

MAAN SEC.-8509

3.274 Kg/Mtr.

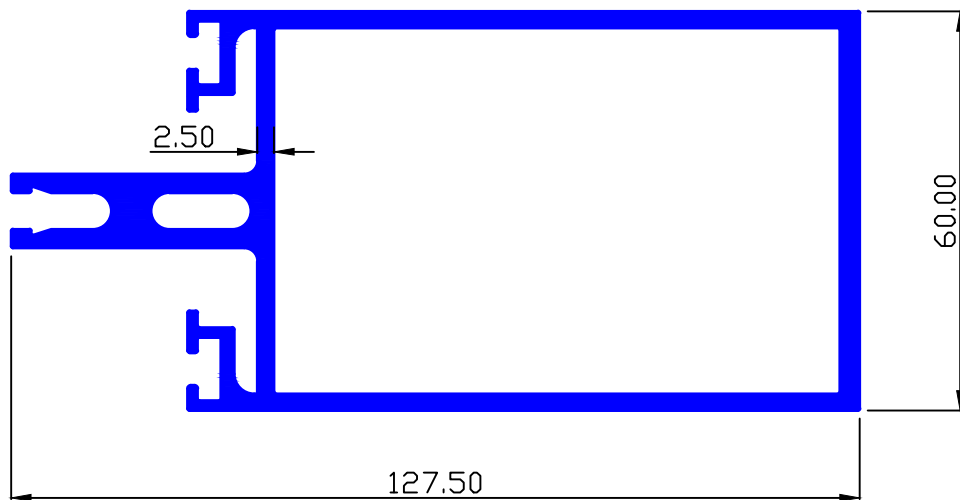

MAAN SEC.-9109

1.851 Kg/Mtr.

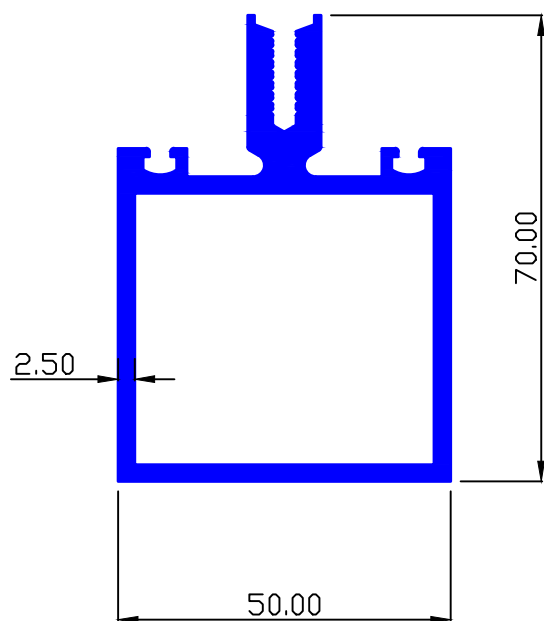

MAAN SEC.-9110

2.389 Kg/Mtr.

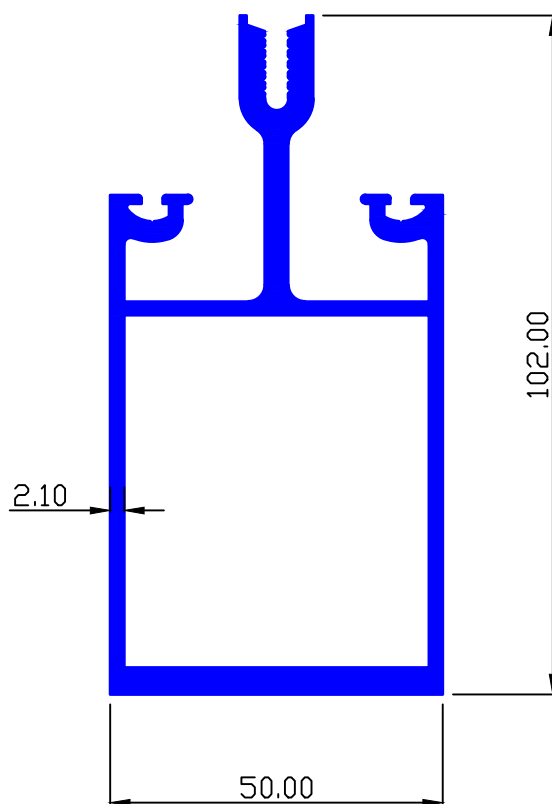



MAAN ALUMINIUM LTD.

CURTAIN WALL

MAAN SEC.-89844

1.526 Kg/Mtr.

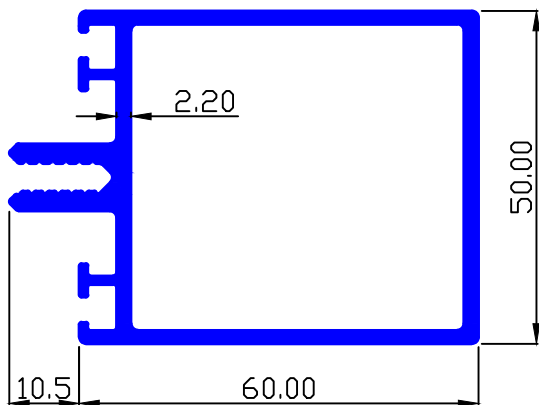

MAAN SEC.-89853

1.794 Kg/Mtr.

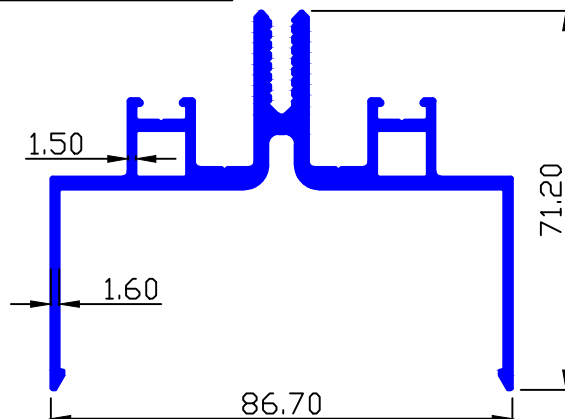

MAAN SEC.-89852

1.945 Kg/Mtr.

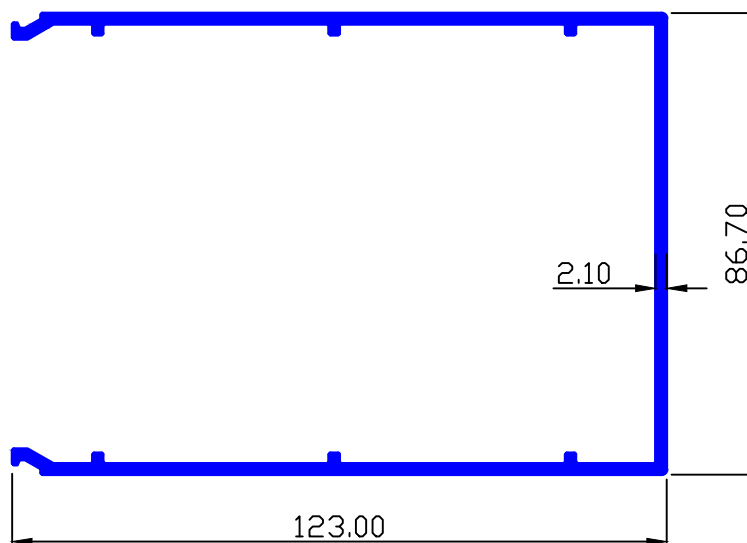

MAAN SEC.-89961

2.889 Kg/Mtr.

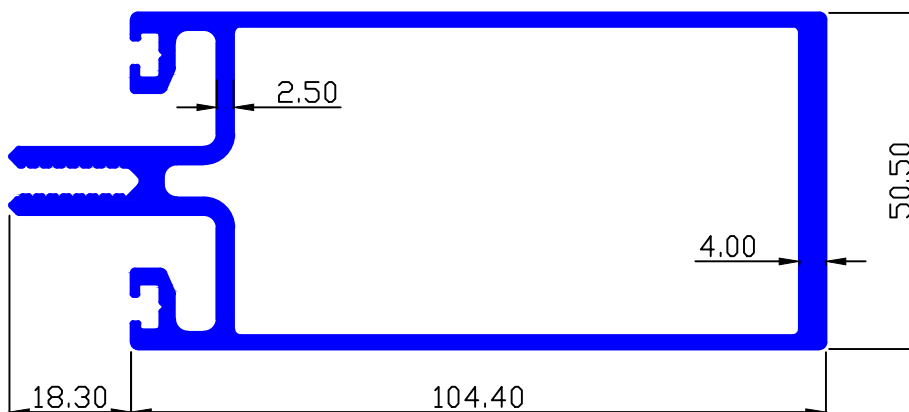



MAAN ALUMINIUM LTD.

CURTAIN WALL

MAAN SEC.-89962

3.675 Kg/Mtr.

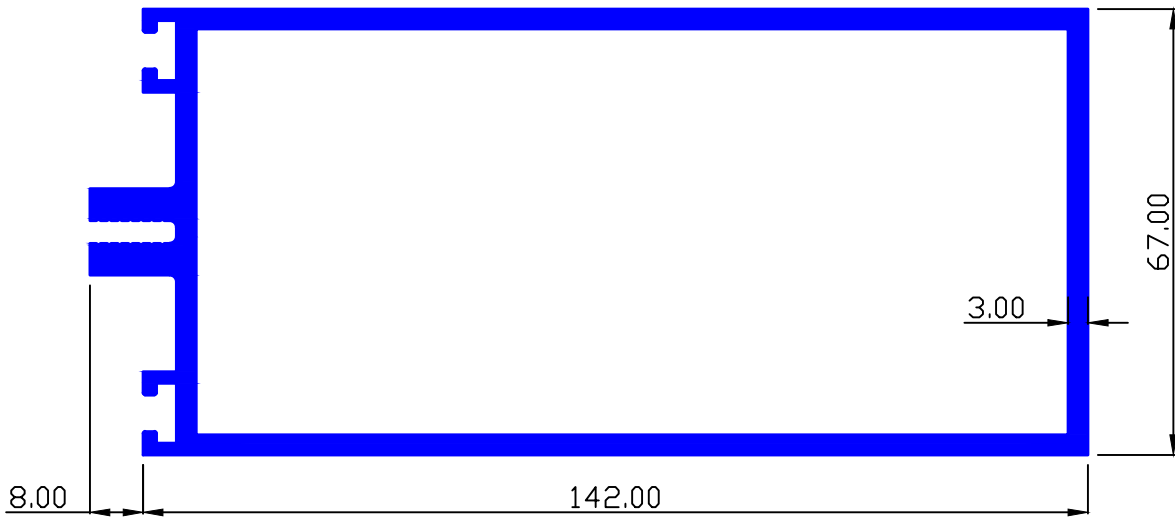

MAAN SEC.-89975

3.506 Kg/Mtr.

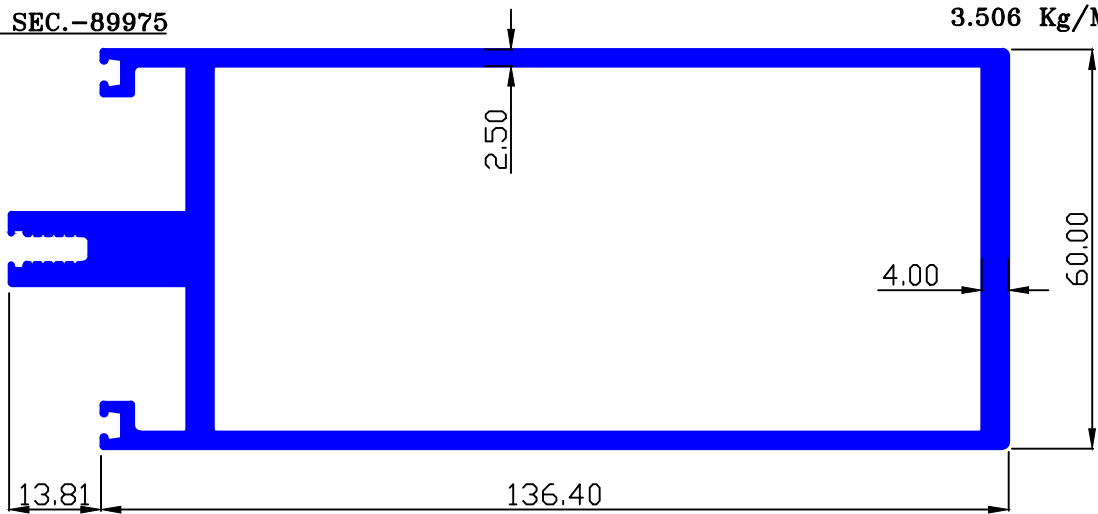

MAAN SEC.-90130

2.198 Kg/Mtr.

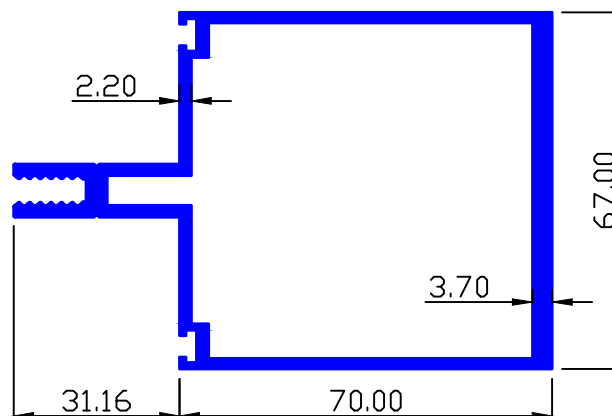



MAAN ALUMINIUM LTD.

CURTAIN WALL

MAAN SEC.-90200

0.978 Kg/Mtr.

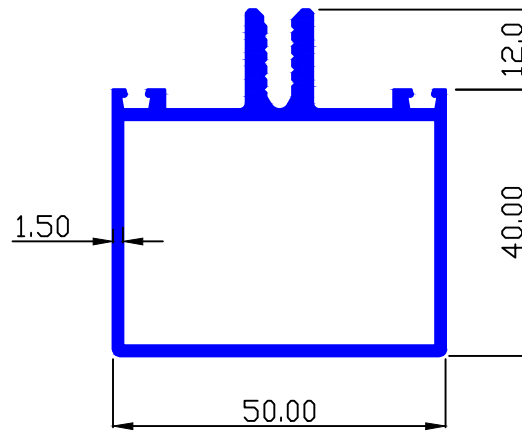

MAAN SEC.-90221

2.726 Kg/Mtr.

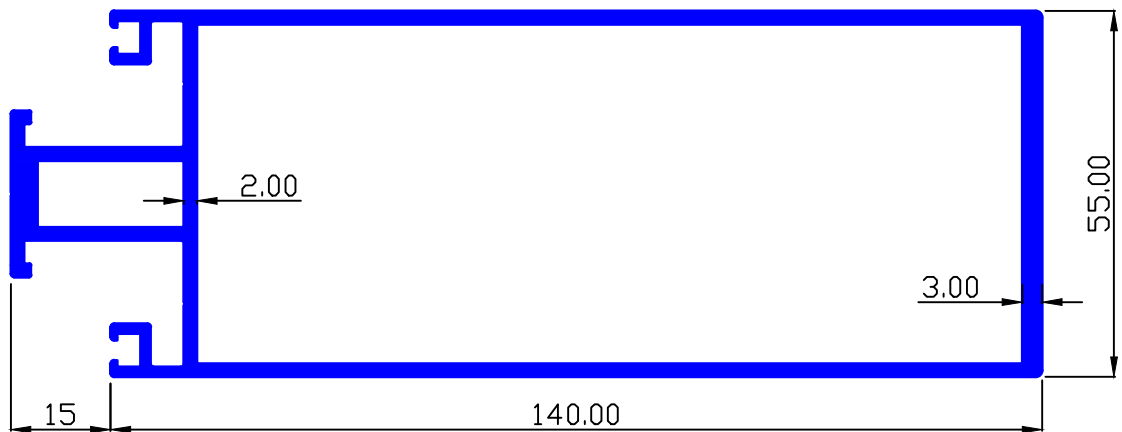

MAAN SEC.-90223

2.492 Kg/Mtr.

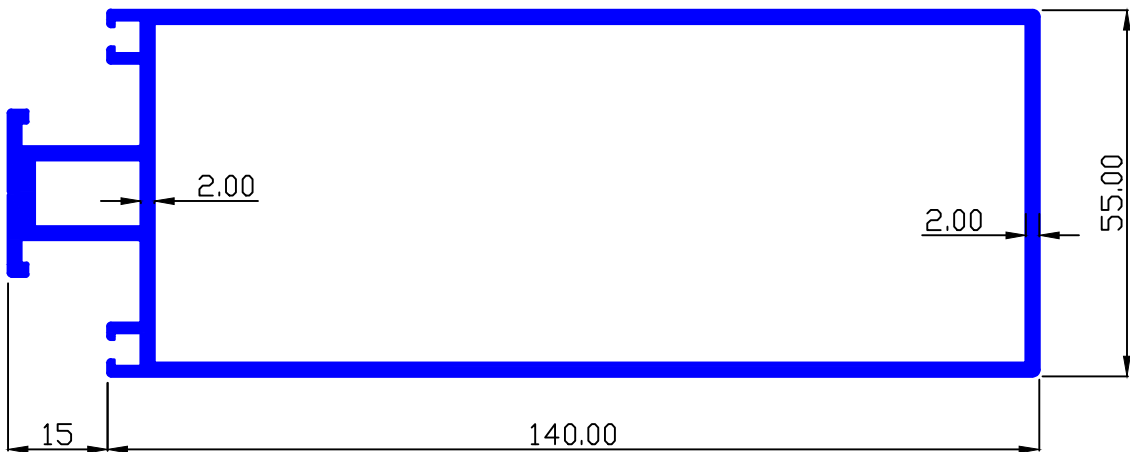



MAAN ALUMINIUM LTD.

CURTAIN WALL

MAAN SEC.-90229

1.736 Kg/Mtr.

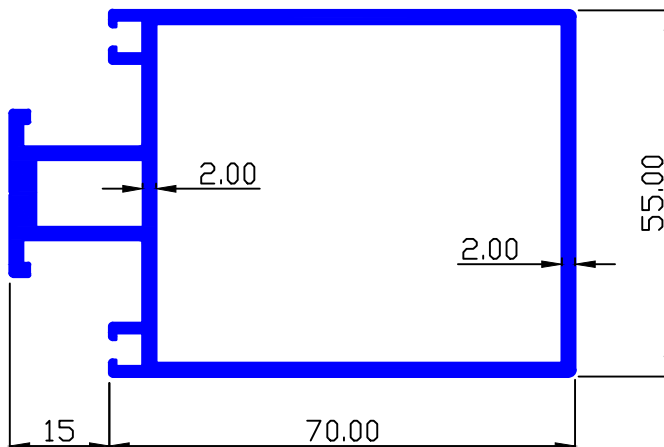

MAAN SEC.-90317

1.604 Kg/Mtr.

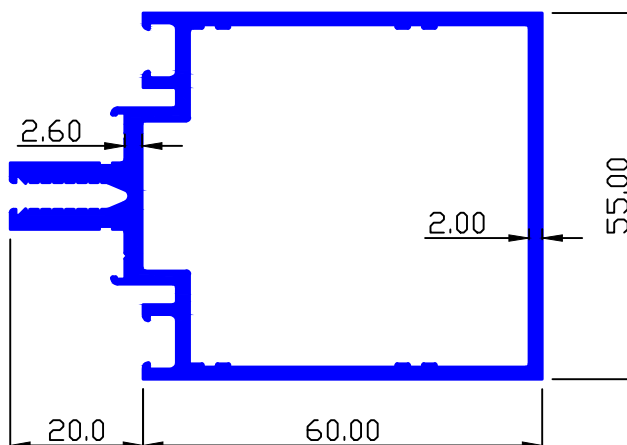

MAAN SEC.-90389

2.150 Kg/Mtr.

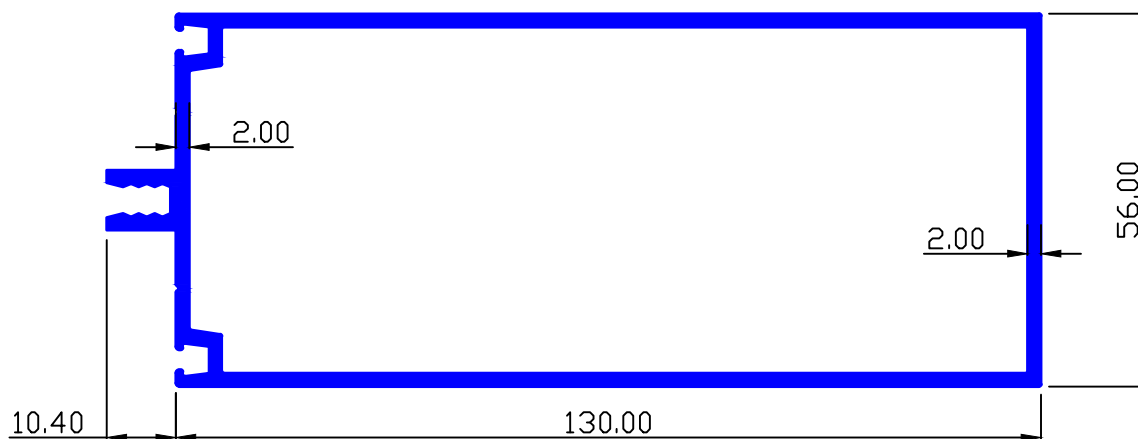



**CURTAIN WALL AND
GLAZING SYSTEMS**

SEC. NO.-90395

WT.-1.665 Kg/Mtr.

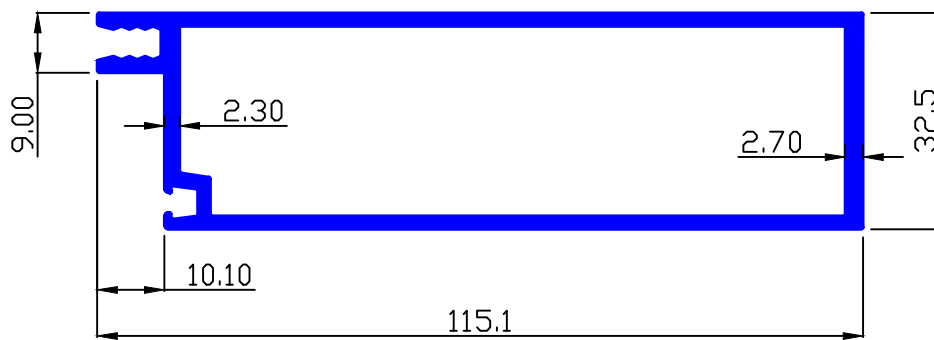

SEC. NO.-90396

WT.-0.384 Kg/Mtr.

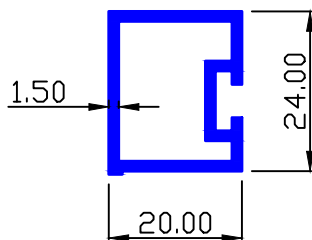

SEC. NO.-90394

WT.-0.172 Kg/Mtr.

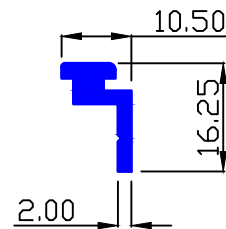

SEC. NO.-90389

WT.-2.150 Kg/Mtr.

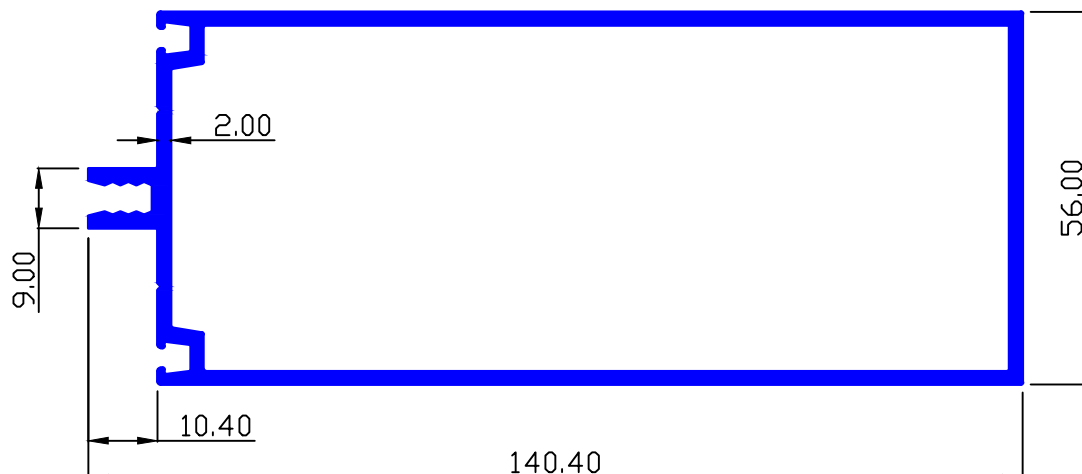



**CURTAIN WALL AND
GLAZING SYSTEMS**

SEC. NO.-90317

WT.-1.604 Kg/Mtr.

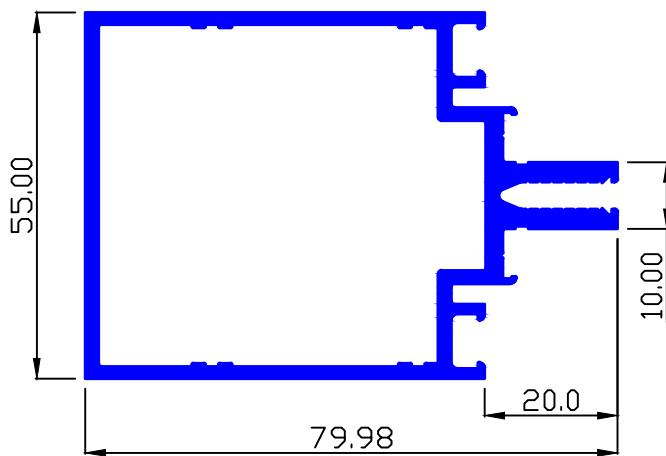

SEC. NO.-90319

WT.-0.302 Kg/Mtr.

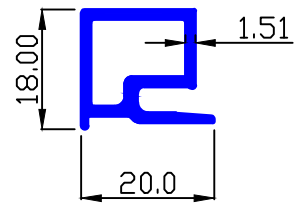

SEC. NO.-90304

WT.-0.209 Kg/Mtr.

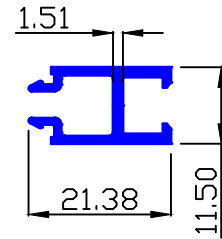

SEC. NO.-90318

WT.-3.032 Kg/Mtr.

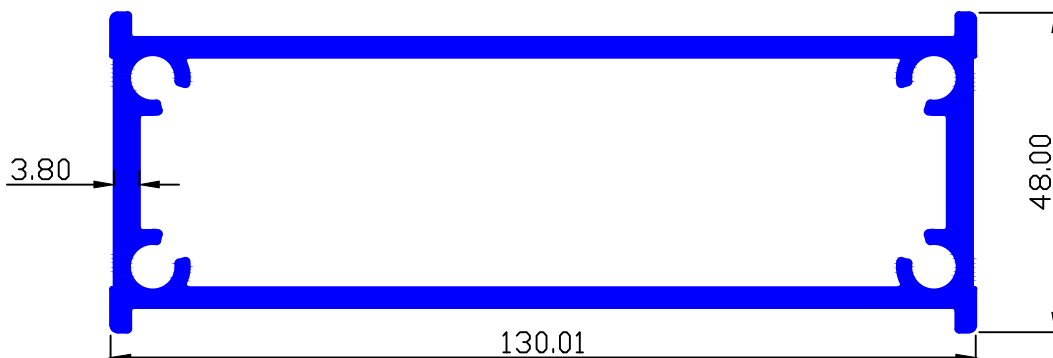

SEC. NO.-90302

WT.-0.271 Kg/Mtr.

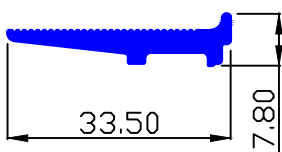

SEC. NO.-90301

WT.-0.293 Kg/Mtr.

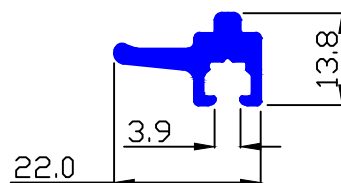

SEC. NO.-90300

WT.-0.199 Kg/Mtr.

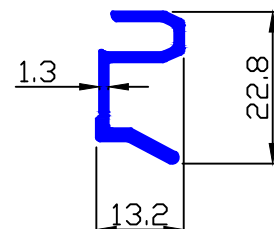



**CURTAIN WALL AND
GLAZING SYSTEMS**

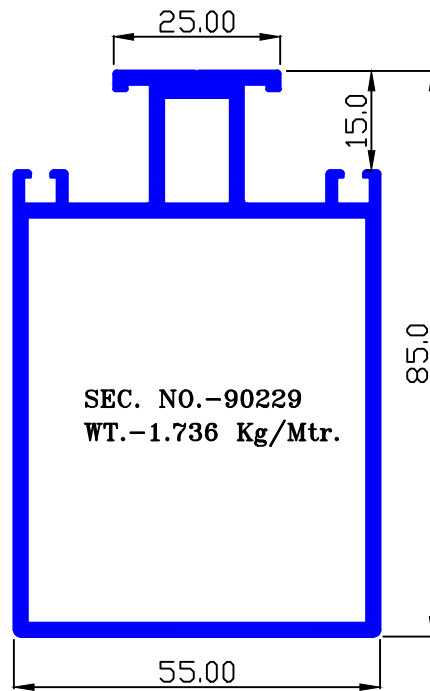
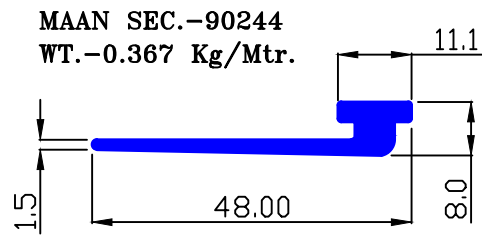
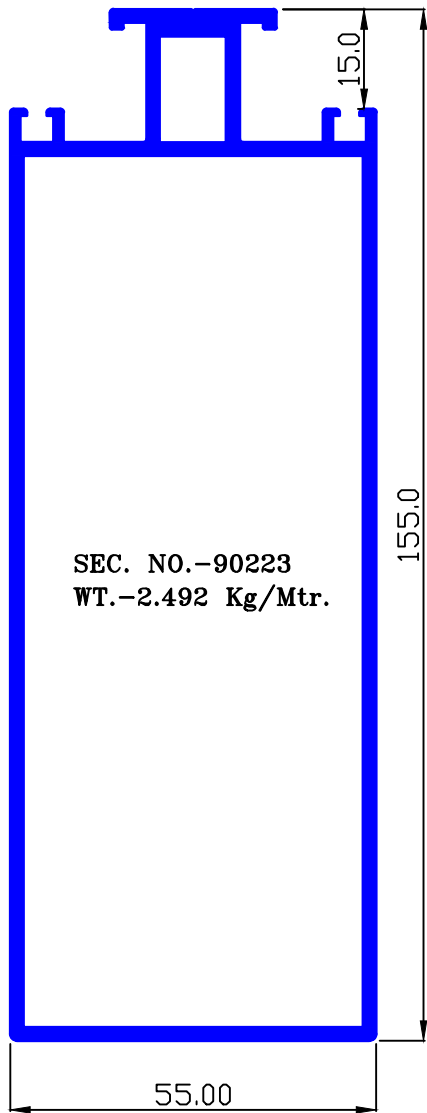

SEC. NO.-90228
WT.-0.314 Kg/Mtr.

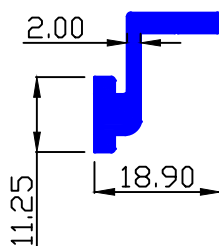

SEC. NO.-90220
WT.-0.541 Kg/Mtr.

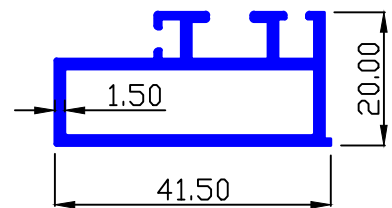



**CURTAIN WALL AND
GLAZING SYSTEMS**

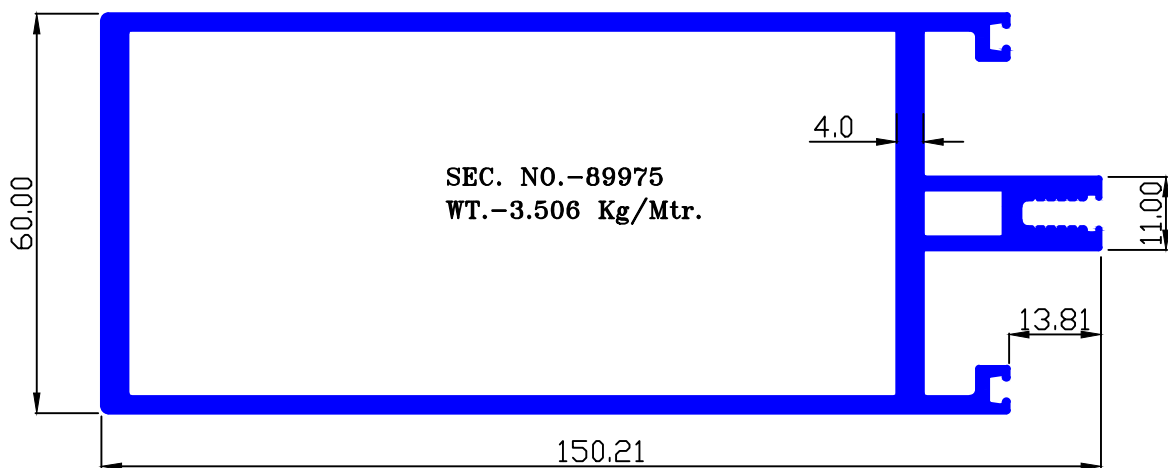
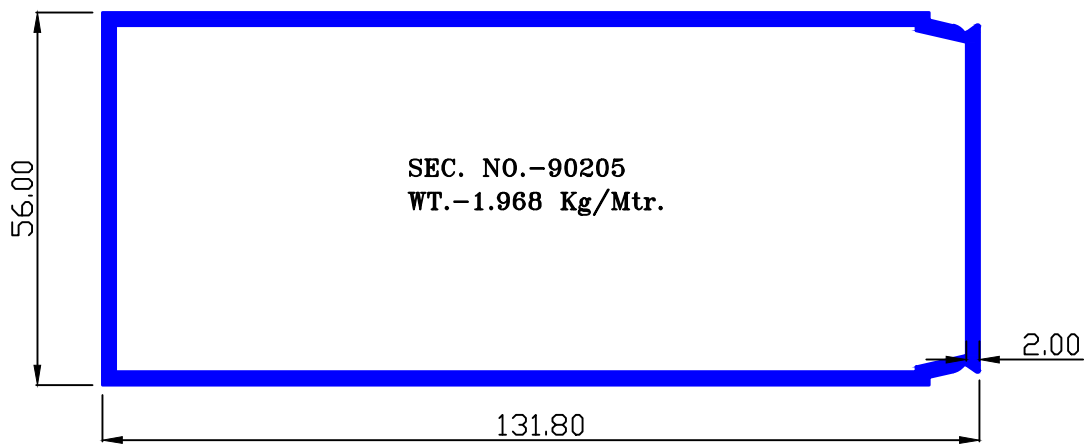
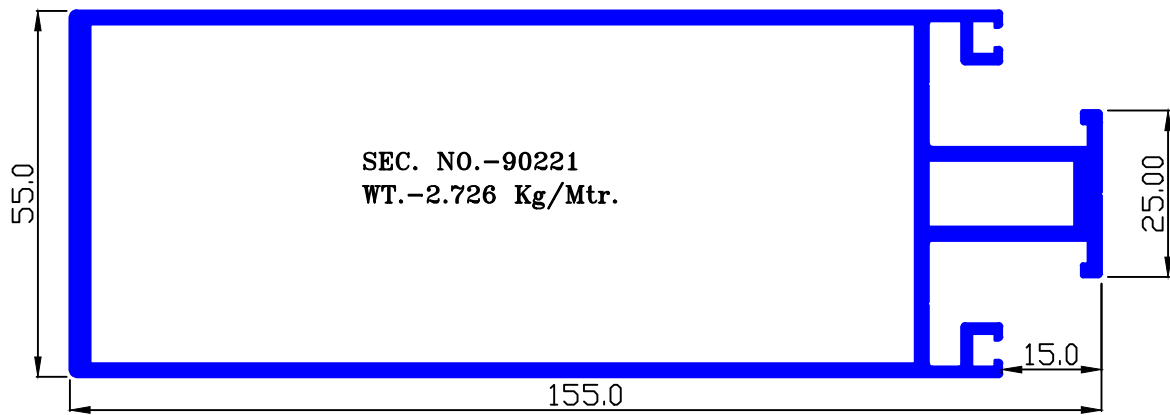



**CURTAIN WALL AND
GLAZING SYSTEMS**

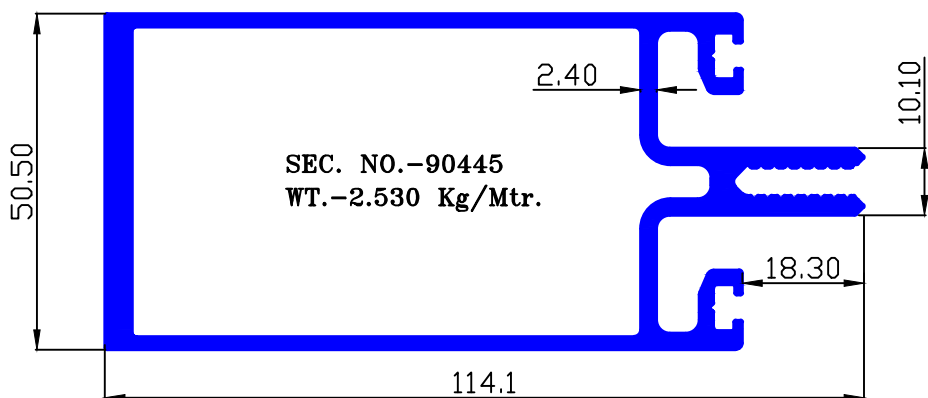
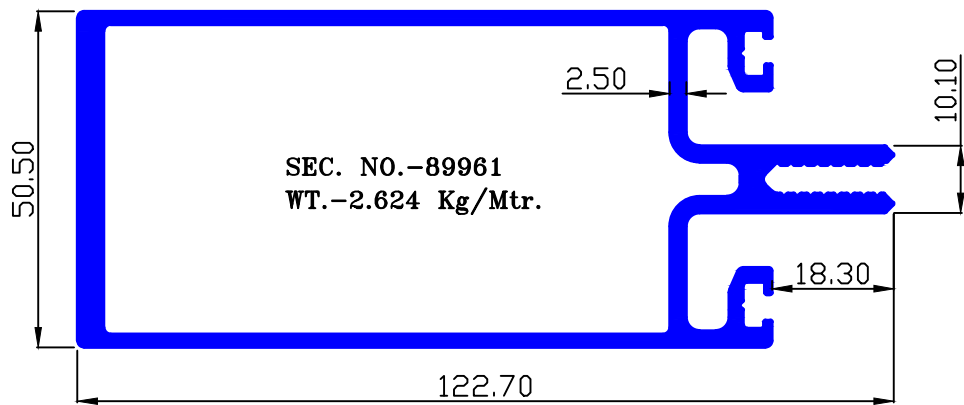
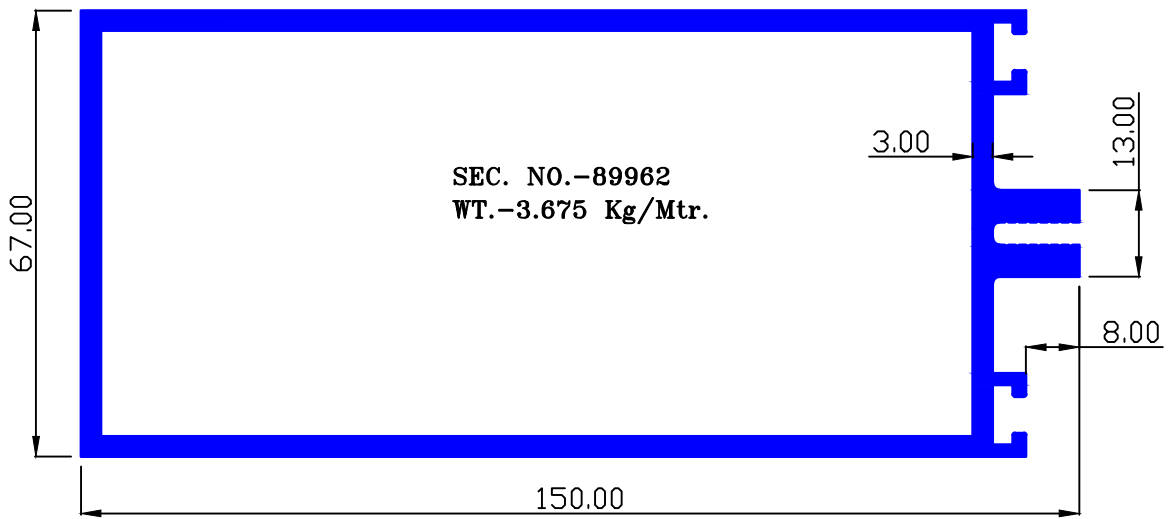



**CURTAIN WALL AND
GLAZING SYSTEMS**

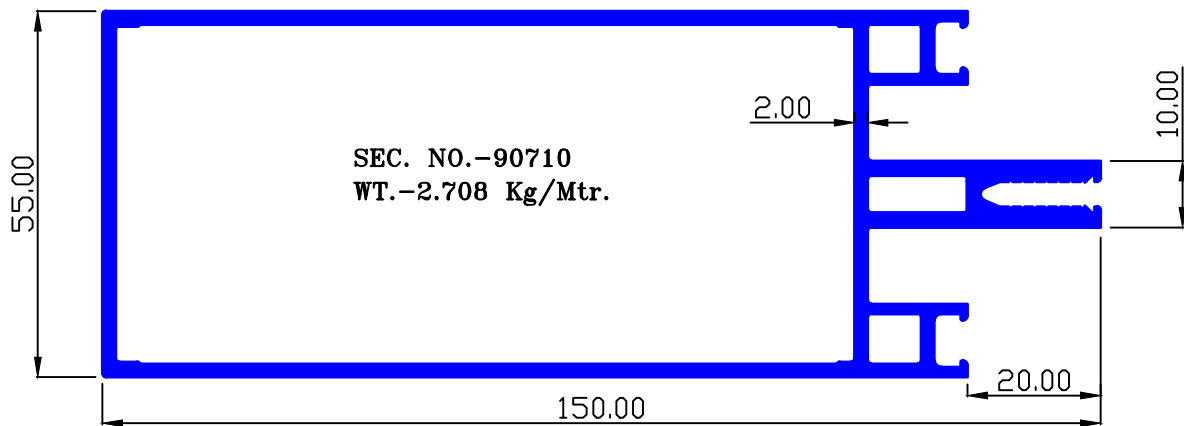
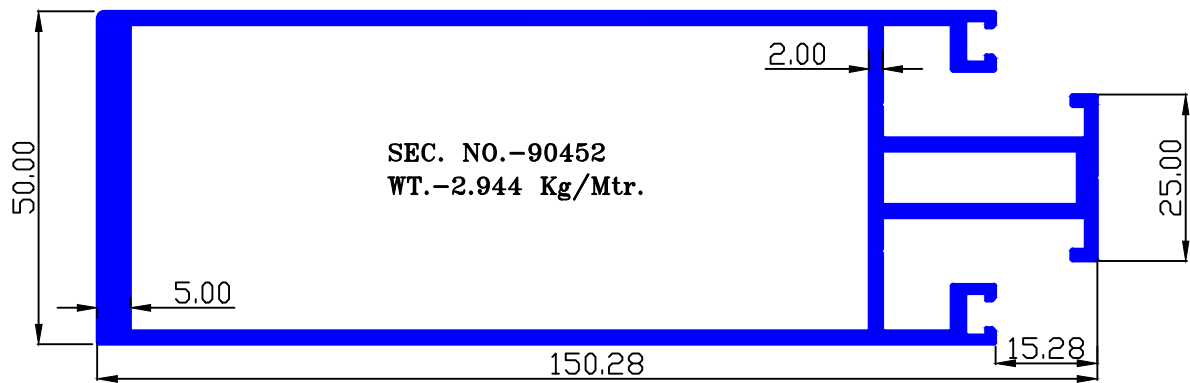
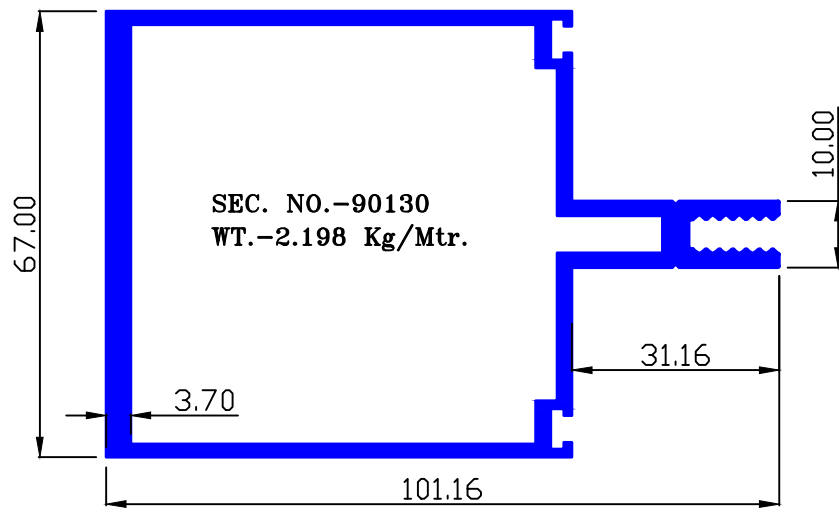



**CURTAIN WALL AND
GLAZING SYSTEMS**

SEC. NO.-90711

WT.-1.670 Kg/Mtr.

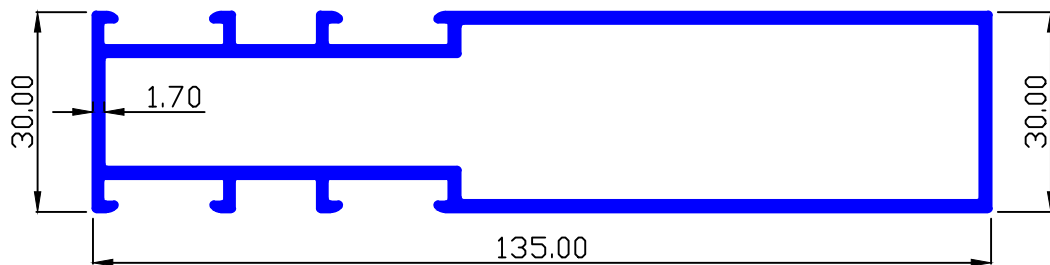

SEC. NO.-90222

WT.-0.714 Kg/Mtr.

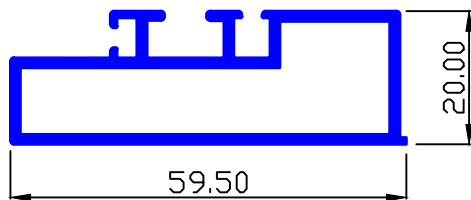

SEC. NO.-90200

WT.-0.978 Kg/Mtr.

