

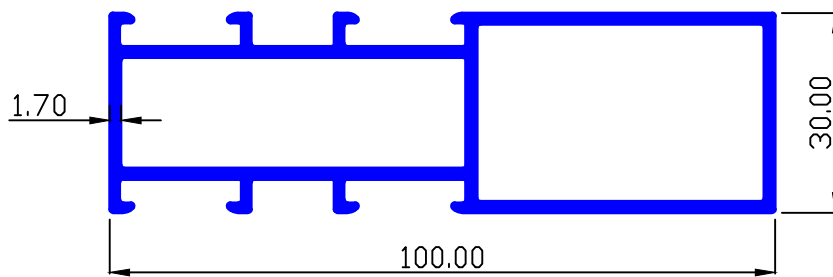

CASEMENT

MAAN SEC.-90316

1.422 Kg/Mtr.



MAAN SEC.-90315

1.428 Kg/Mtr.

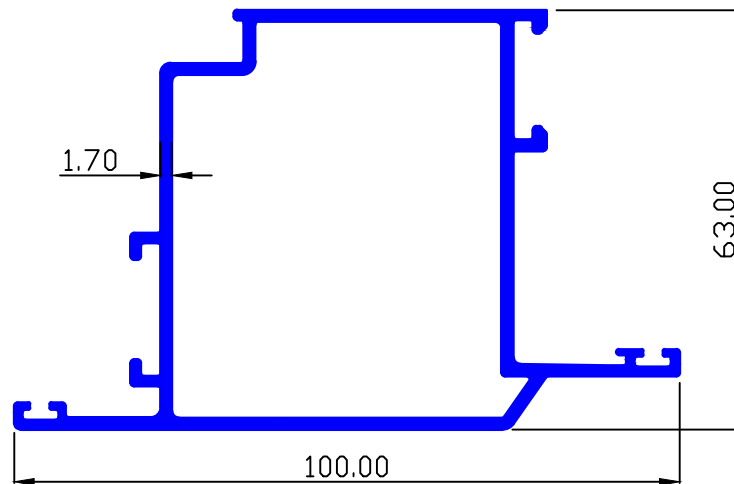

MAAN SEC.-90314

1.273 Kg/Mtr.

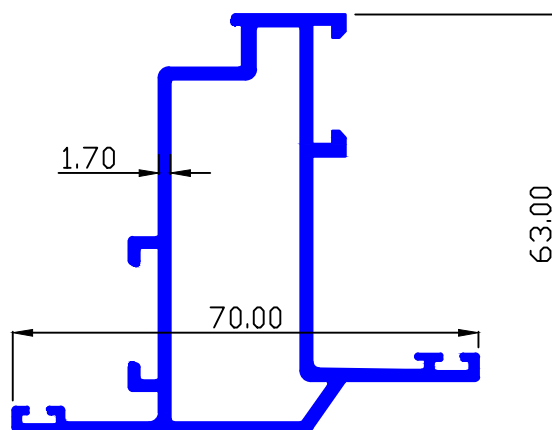



CASEMENT

MAAN SEC.-90313

0.817 Kg/Mtr.

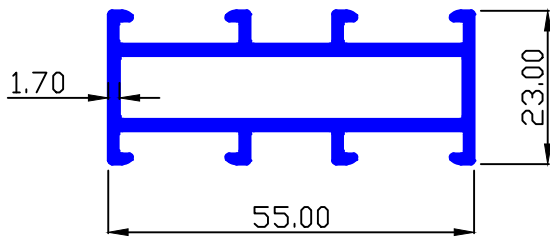

MAAN SEC.-90310

1.695 Kg/Mtr.

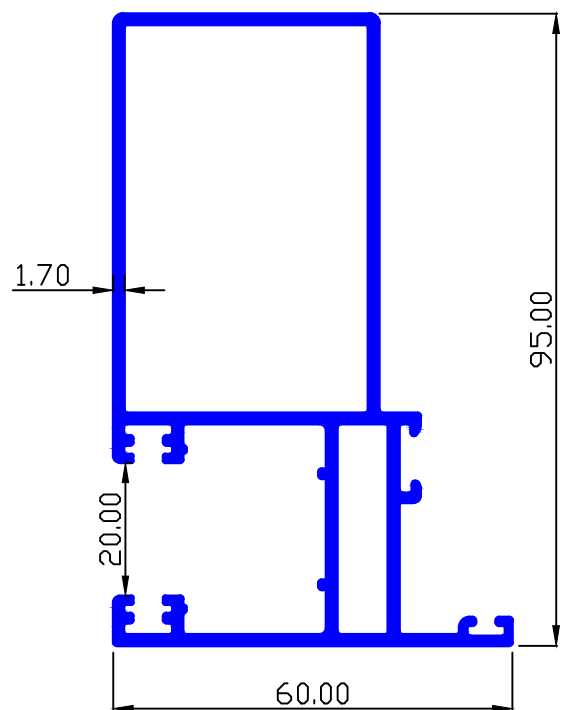

MAAN SEC.-89909

0.513 Kg/Mtr.

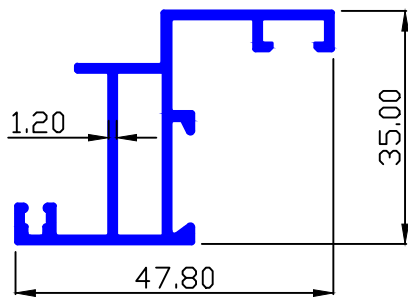

MAAN SEC.-90308

0.974 Kg/Mtr.

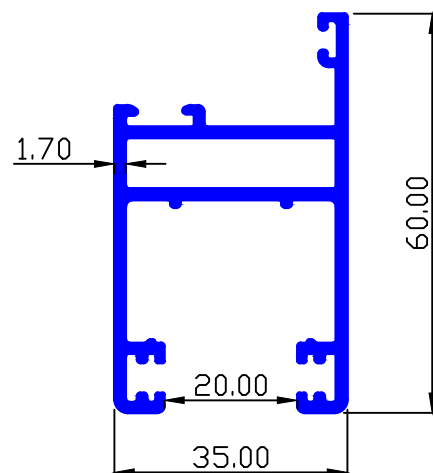

MAAN SEC.-89980

0.155 Kg/Mtr.

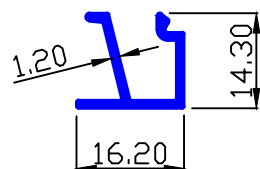

W.T. RANGE 0.540 TO 0.650 Kg/12'



CASEMENT

MAAN SEC.-90309

1.692 Kg/Mtr.

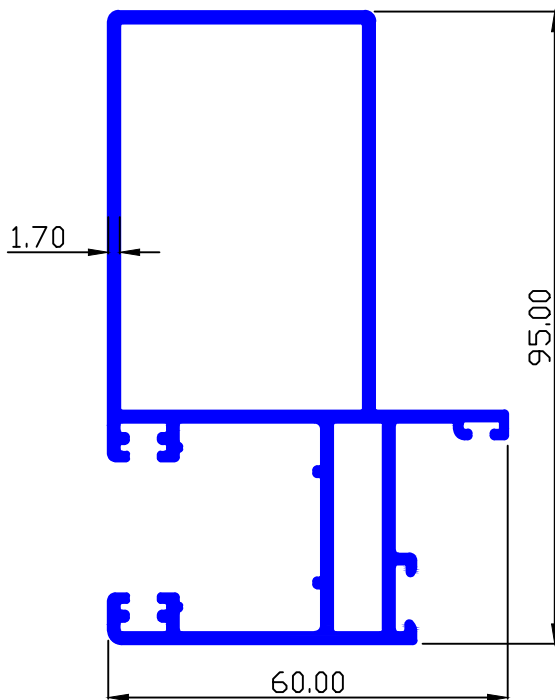

MAAN SEC.-90299

1.050 Kg/Mtr.

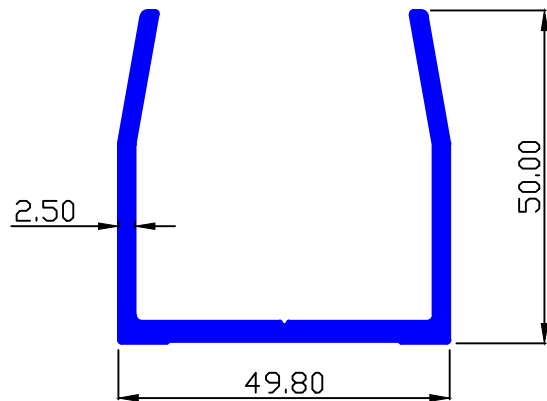

MAAN SEC.-90298

0.377 Kg/Mtr.

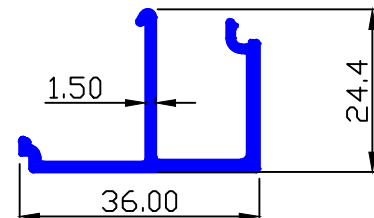

MAAN SEC.-90307

1.087 Kg/Mtr.

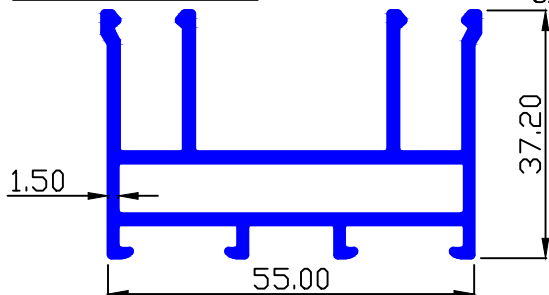

MAAN SEC.-90297

0.300 Kg/Mtr.

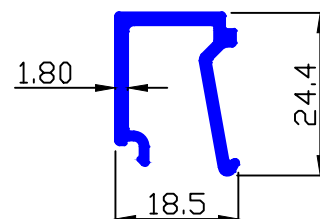

MAAN SEC.-90303

0.460 Kg/Mtr.

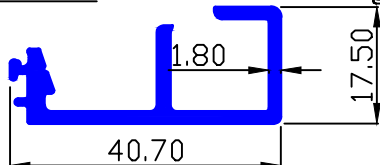

MAAN SEC.-90296

0.223 Kg/Mtr.

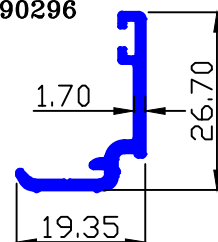



CASEMENT

MAAN SEC.-90306

1.694 Kg/Mtr.

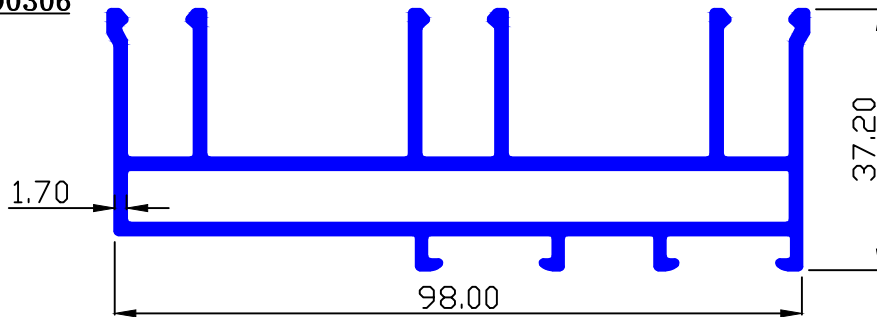

MAAN SEC.-90305

2.006 Kg/Mtr.

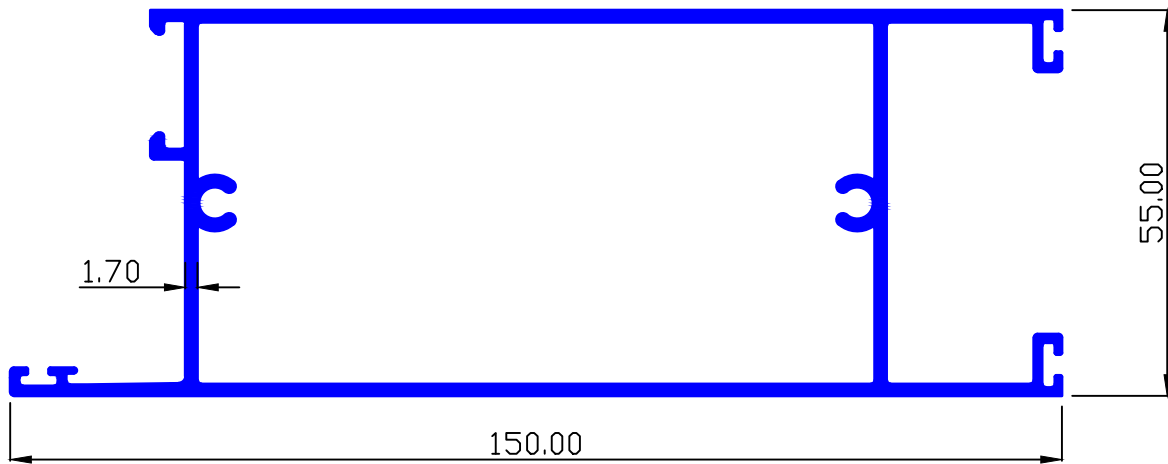

MAAN SEC.-90295

0.194 Kg/Mtr.

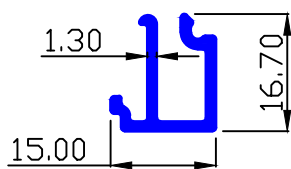

MAAN SEC.-90294

0.364 Kg/Mtr.

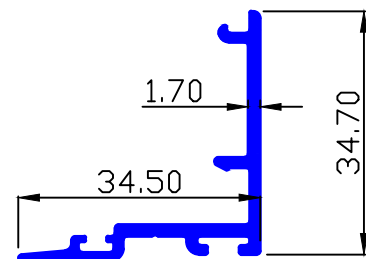

MAAN SEC.-90293

0.115 Kg/Mtr.

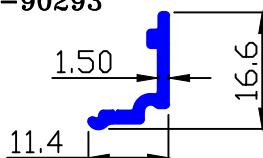

MAAN SEC.-90292

0.117 Kg/Mtr.

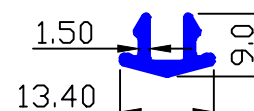



CASEMENT

MAAN SEC.-90123

0.551 Kg/Mtr.

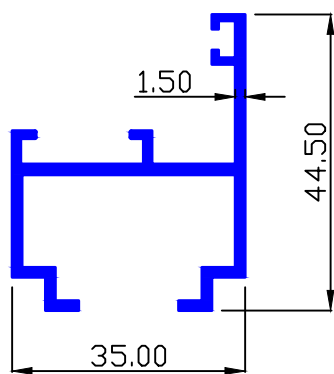

MAAN SEC.-90112

0.818 Kg/Mtr.

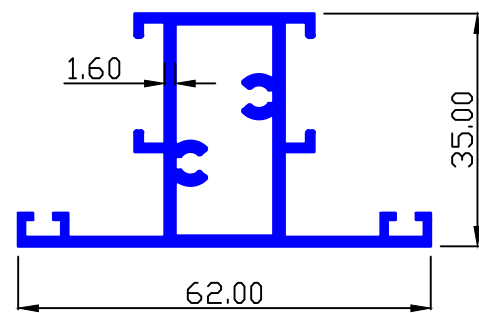

MAAN SEC.-90113

1.141 Kg/Mtr.

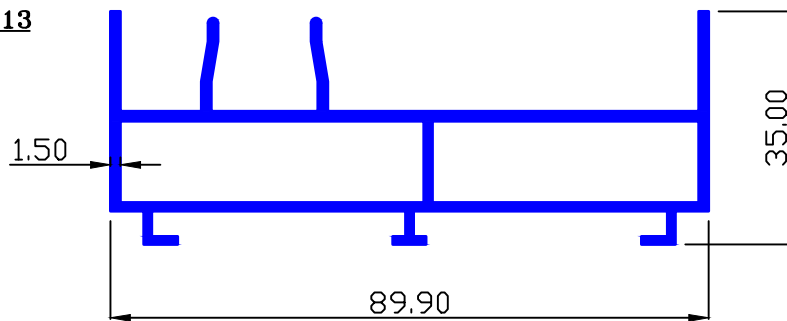

MAAN SEC.-90111

2.107 Kg/Mtr.

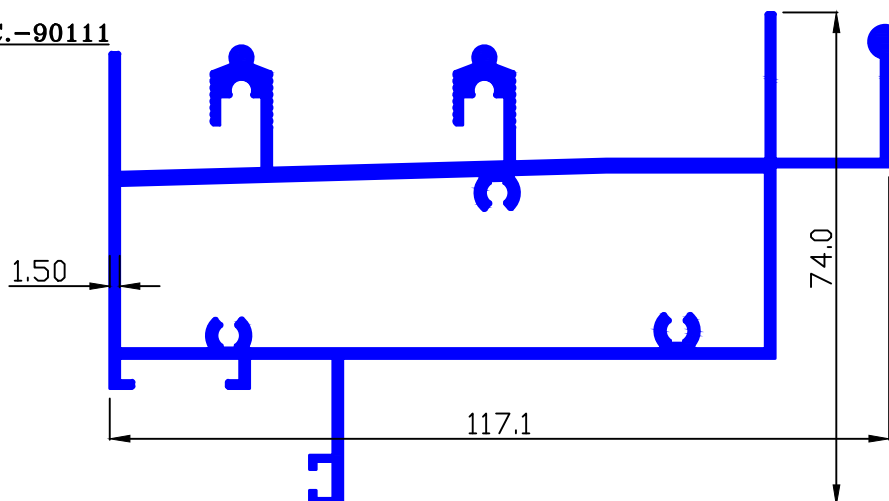



CASEMENT

MAAN SEC.-89981

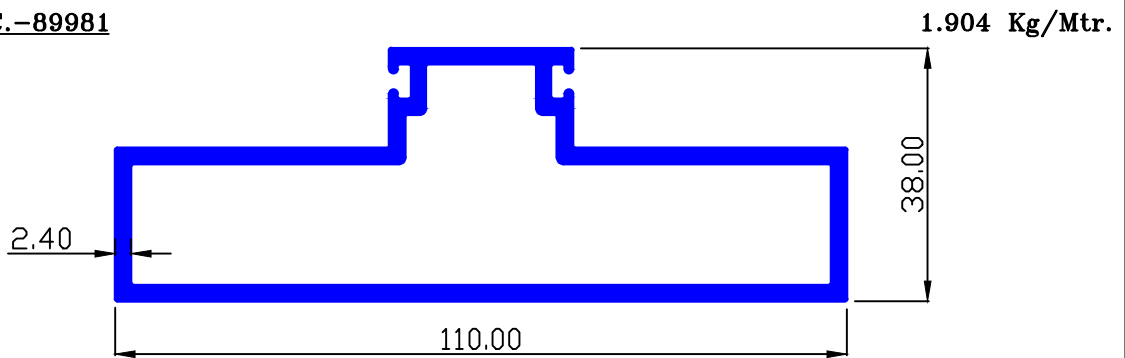

W.T. RANGE 6.600 TO 7.500 Kg/12'

MAAN SEC.-90109

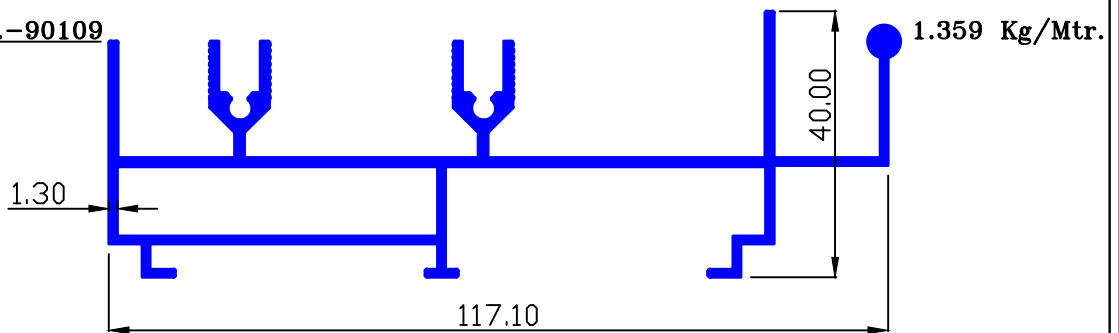

MAAN SEC.-90108

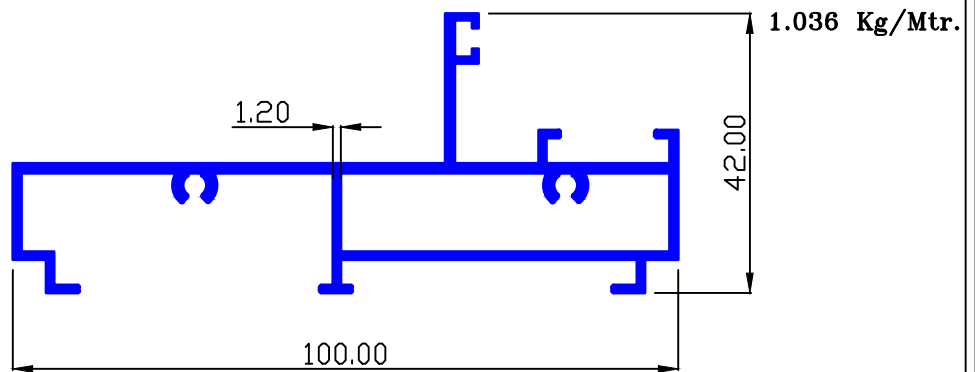



CASEMENT

MAAN SEC.-89980

0.155 Kg/Mtr.

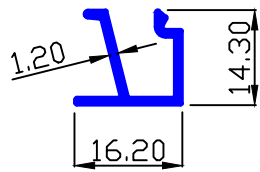

W.T. RANGE 0.540 TO 0.650 Kg/12'

MAAN SEC.-89904

1.308 Kg/Mtr.

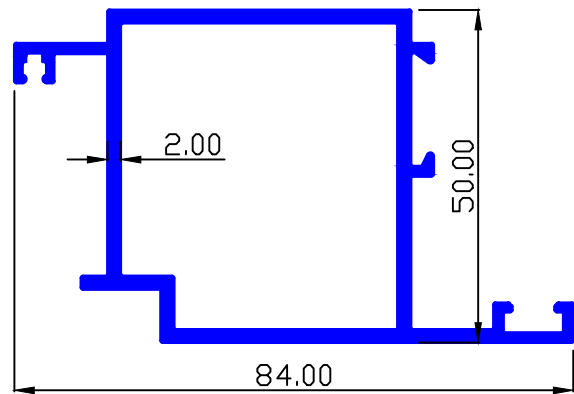

MAAN SEC.-90097

0.614 Kg/Mtr.

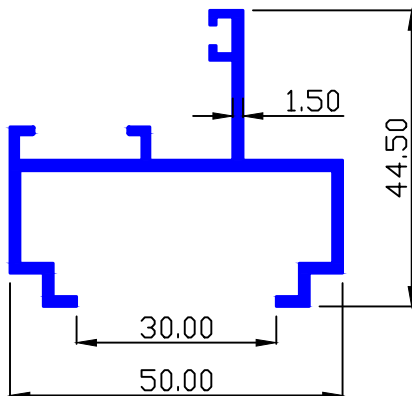

MAAN SEC.-89903

0.674 Kg/Mtr.

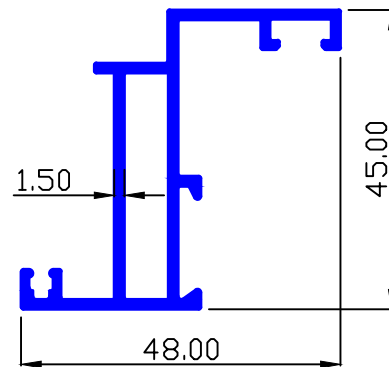



CASEMENT

MAAN SEC.-90107

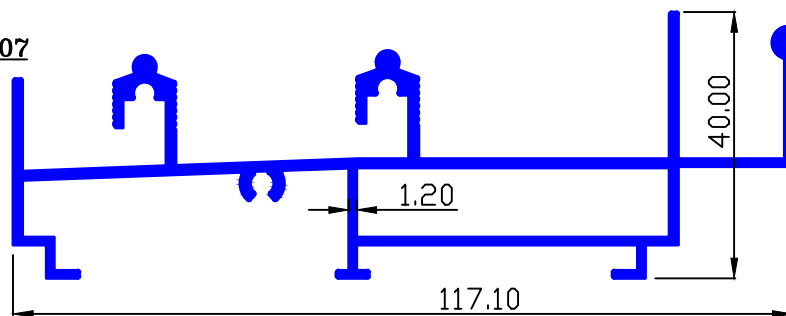

1.369 Kg/Mtr.

MAAN SEC.-90101

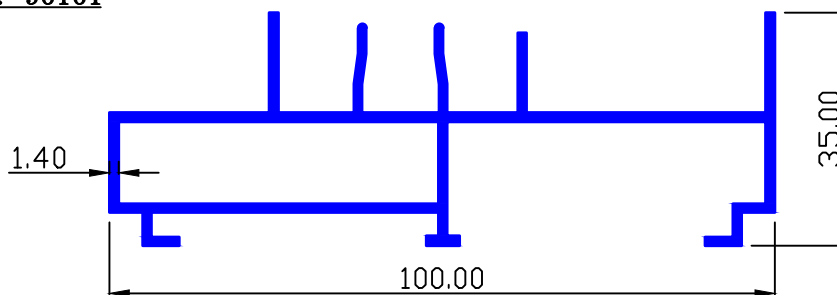

1.053 Kg/Mtr.

MAAN SEC.-90100

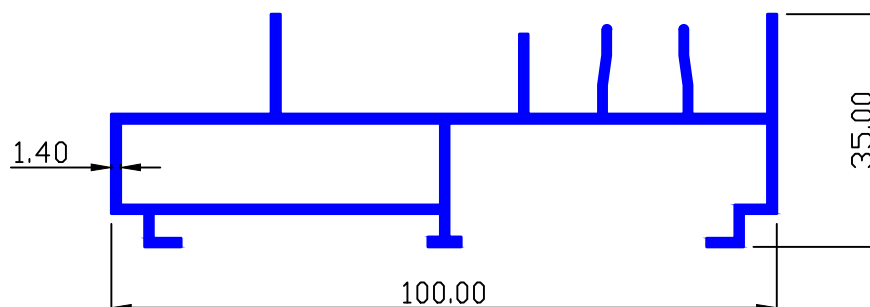

1.053 Kg/Mtr.



CASEMENT

MAAN SEC.-90096

0.493 Kg/Mtr.

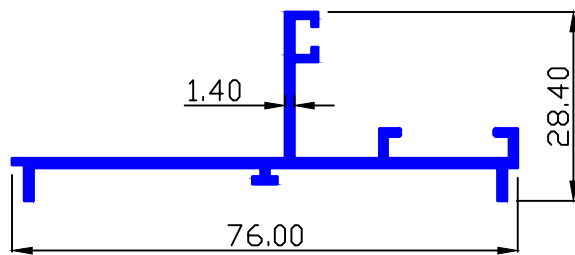

MAAN SEC.-90048

0.978 Kg/Mtr.

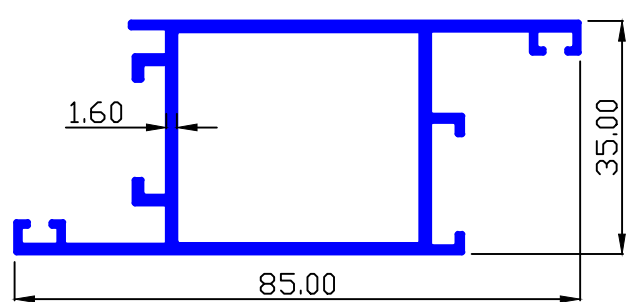

MAAN SEC.-90049

1.025 Kg/Mtr.

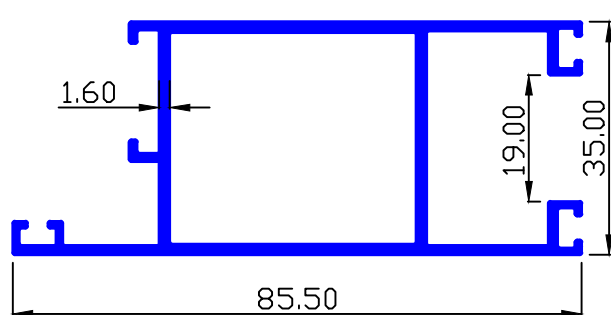

MAAN SEC.-90047

0.758 Kg/Mtr.

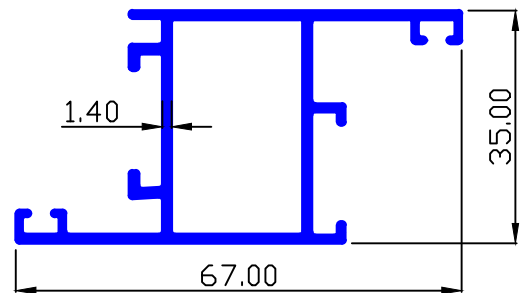

MAAN SEC.-90046

3.183 Kg/Mtr.

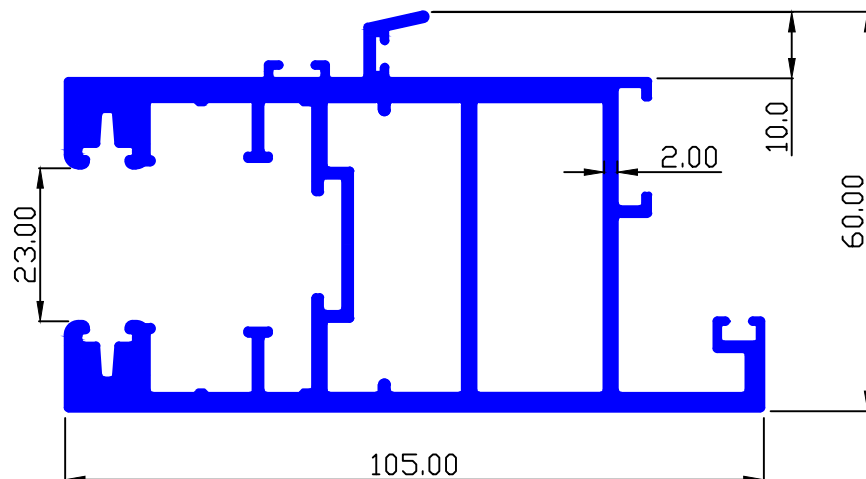



CASEMENT

MAAN SEC.-90045

3.232 Kg/Mtr.

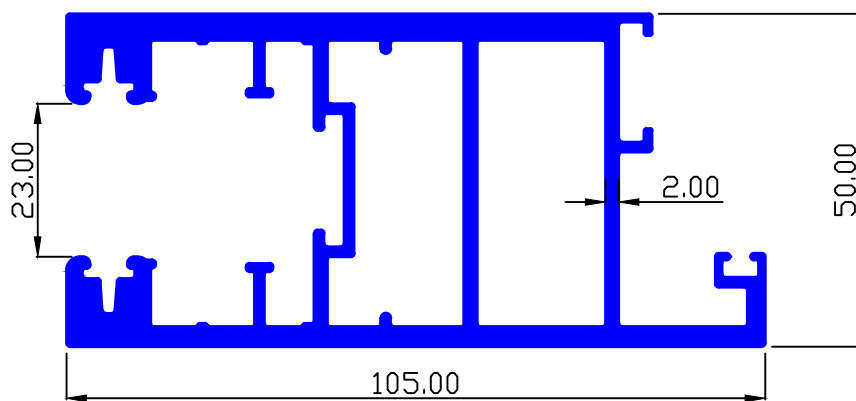

MAAN SEC.-90044

3.268 Kg/Mtr.

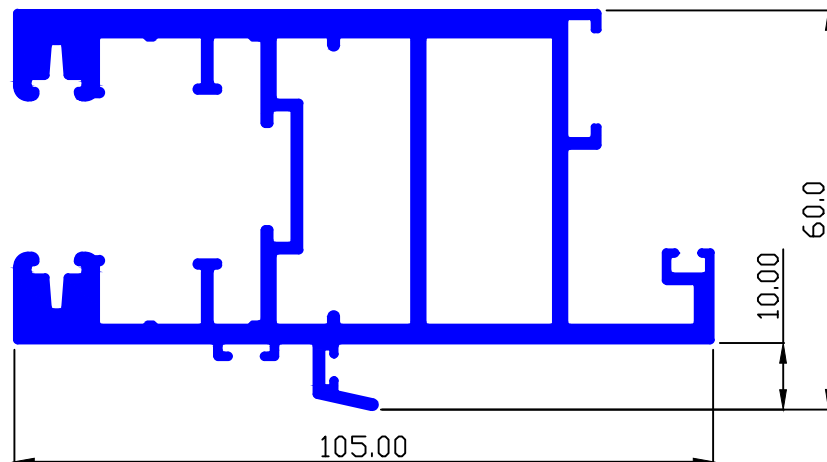

MAAN SEC.-90043

0.185 Kg/Mtr.

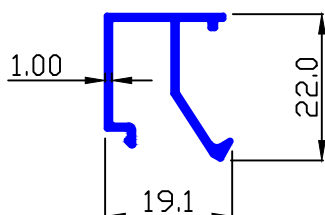

MAAN SEC.-89982

0.524 Kg/Mtr.

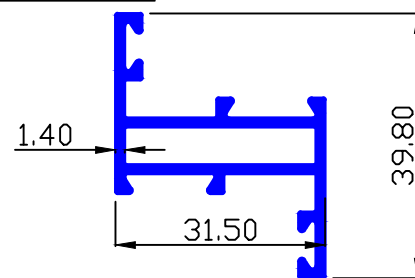

WEIGHT RANGE : 1.820 TO 2.050/12'



CASEMENT

MAAN SEC.-89987

2.170 Kg/Mtr.

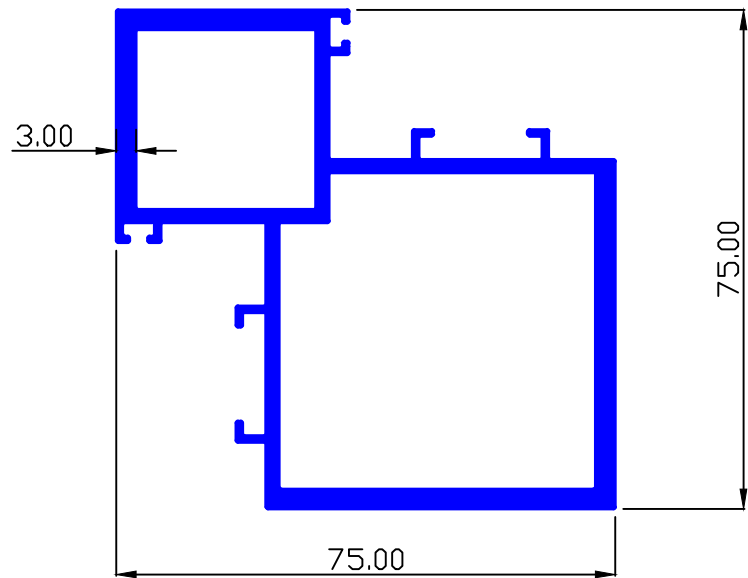

MAAN SEC.-89985

0.725 Kg/Mtr.

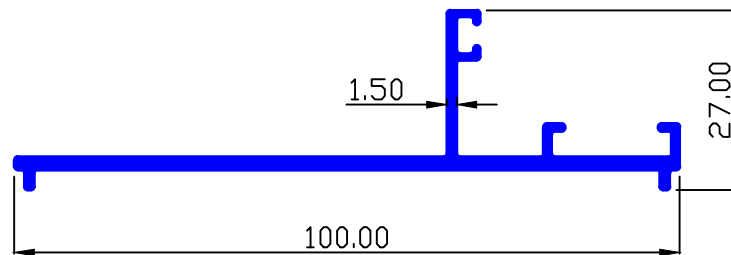

MAAN SEC.-89983

1.851 Kg/Mtr.

