



MAAN ALUMINIUM LTD.

CONTROL PANNEL

MAAN SEC.-90114

0.209 Kg/Mtr.

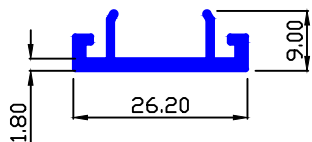

MAAN SEC.-90115

0.117 Kg/Mtr.

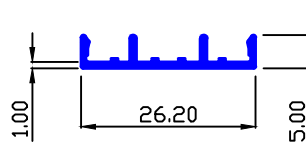

MAAN SEC.-90116

0.271 Kg/Mtr.

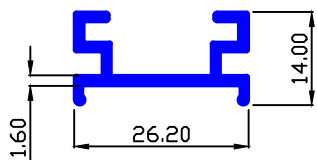

MAAN SEC.-90117

0.408 Kg/Mtr.

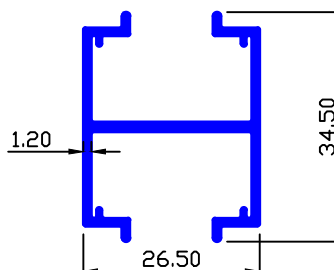

MAAN SEC.-90118

0.240 Kg/Mtr.

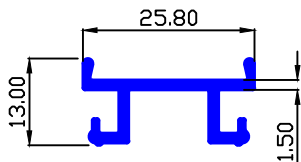

MAAN SEC.-90119

1.176 Kg/Mtr.

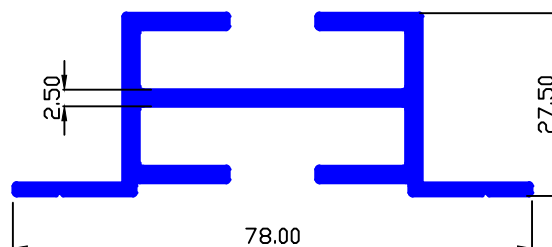

MAAN SEC.-90132

1.602 Kg/Mtr.

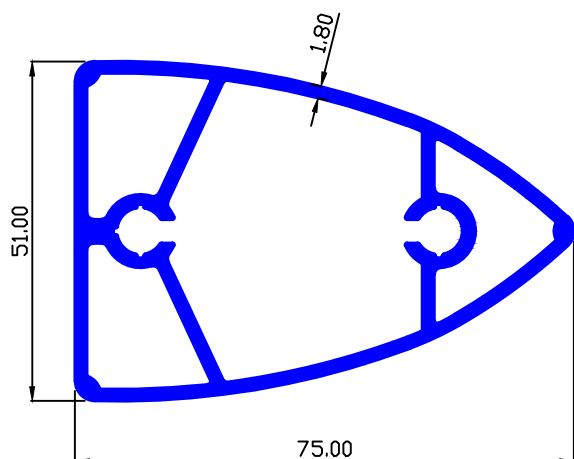

MAAN SEC.-90133

1.542 Kg/Mtr.

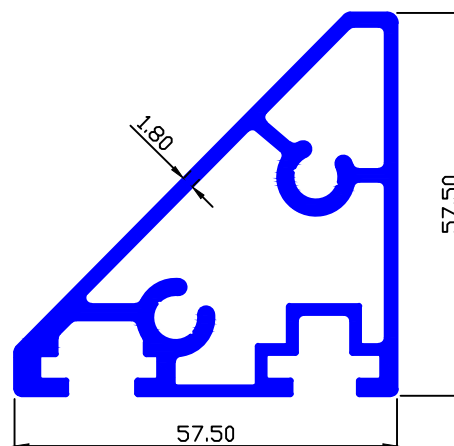



MAAN ALUMINIUM LTD.

CONTROL PANNEL

MAAN SEC.-90151

2.780 Kg/Mtr.

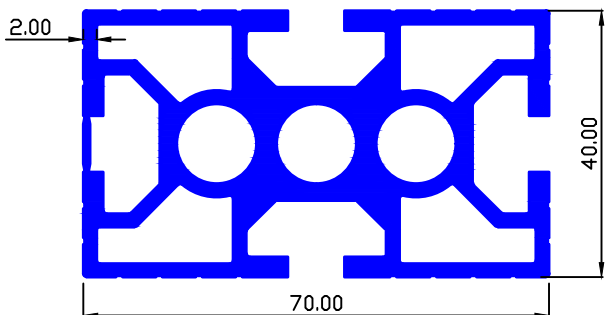

MAAN SEC.-90152

1.599 Kg/Mtr.

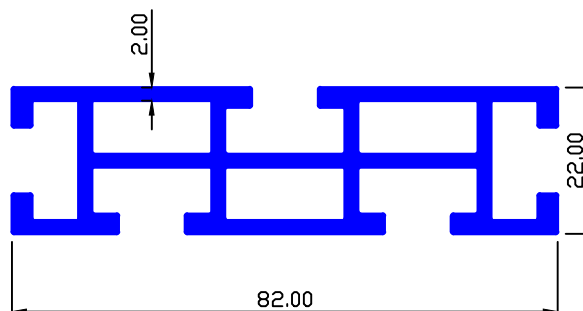

MAAN SEC.-90153

0.842 Kg/Mtr.

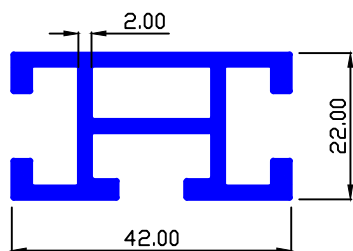

MAAN SEC.-90154

1.601 Kg/Mtr.

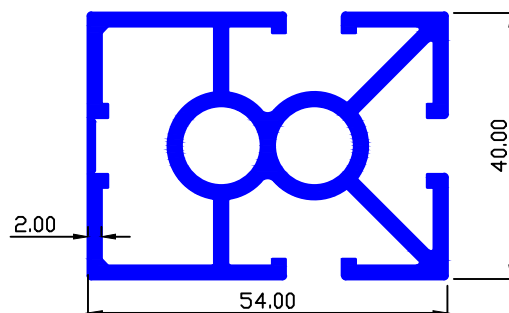

MAAN SEC.-90158

0.646 Kg/Mtr.

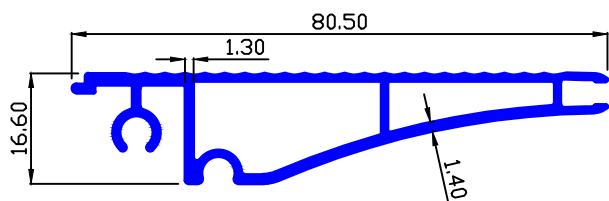

MAAN SEC.-90256

1.587 Kg/Mtr.

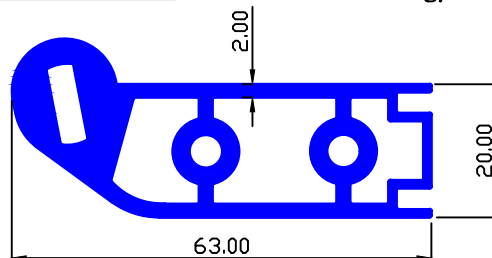

MAAN SEC.-90159

1.543 Kg/Mtr.

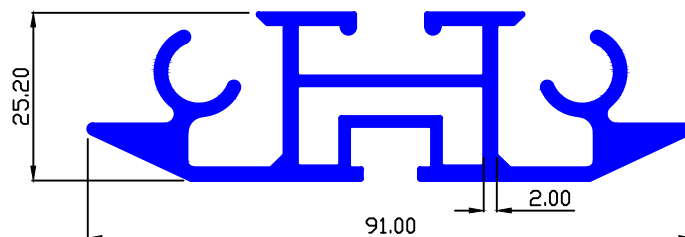



MAAN ALUMINIUM LTD.

CONTROL PANNEL

MAAN SEC.-90253

2.420 Kg/Mtr.

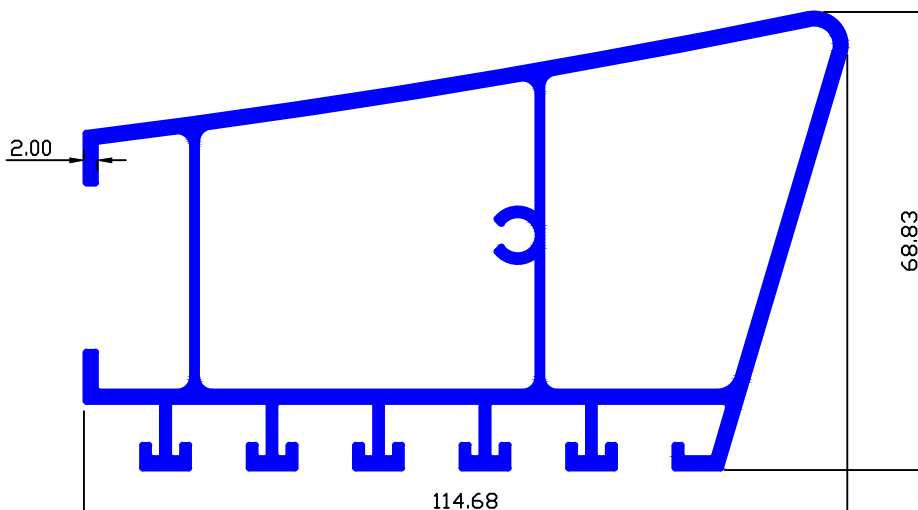

MAAN SEC.-90254

3.380 Kg/Mtr.

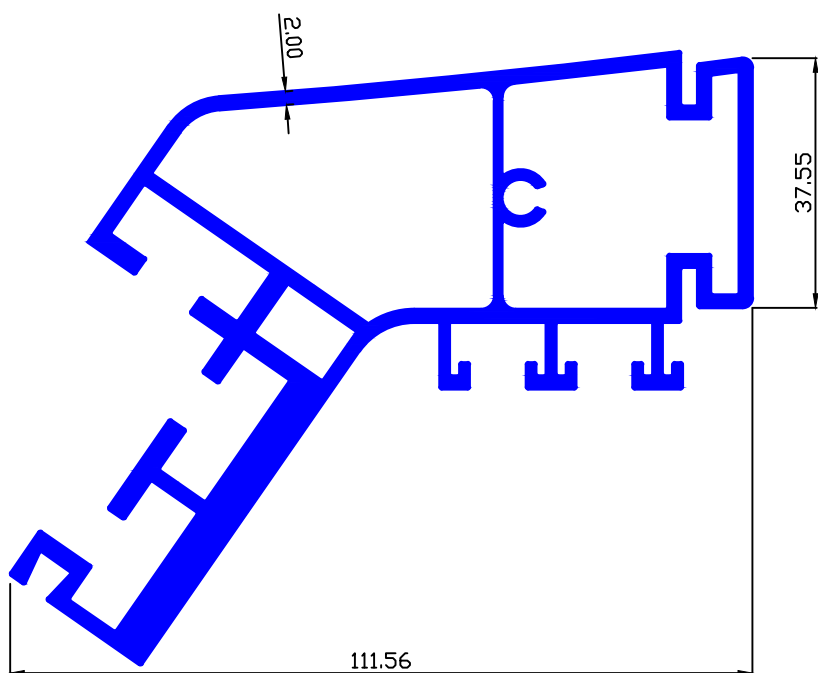



MAAN ALUMINIUM LTD.

CONTROL PANNEL

MAAN SEC.-90255

1.846 Kg/Mtr.

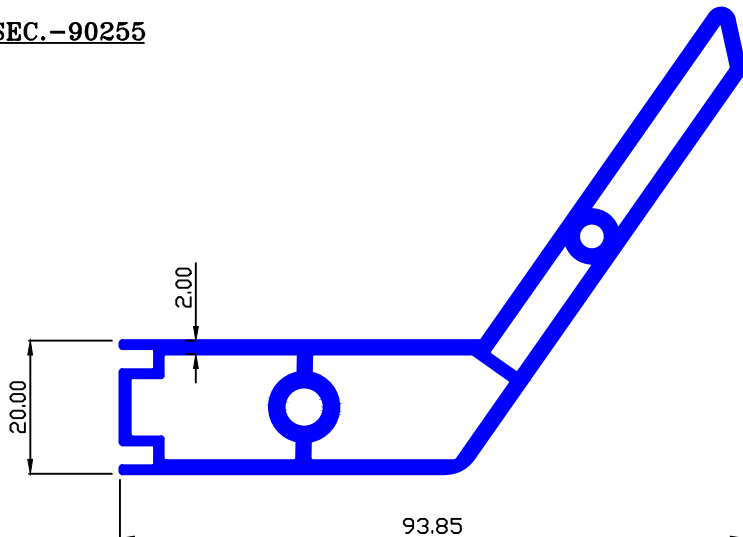

MAAN SEC.-90559

1.949 Kg/Mtr.

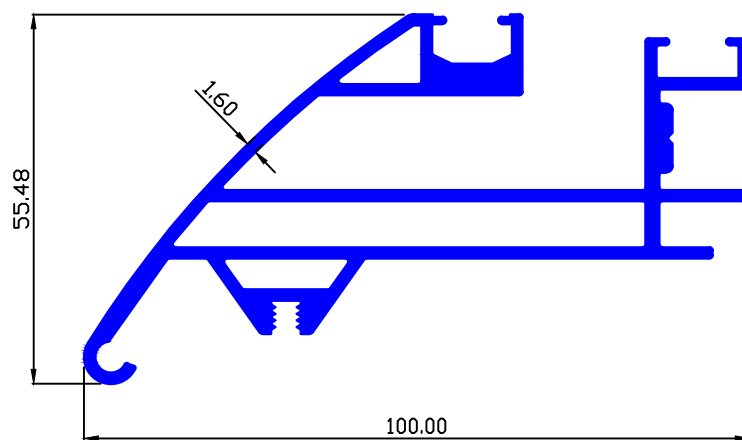

MAAN SEC.-90542

2.303 Kg/Mtr.

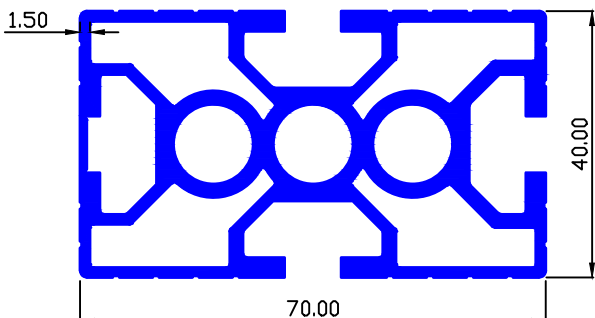

MAAN SEC.-90560

0.186 Kg/Mtr.

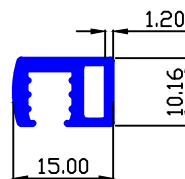



MAAN ALUMINIUM LTD.

CONTROL PANNEL

MAAN SEC.-90649

1.520 Kg/Mtr.

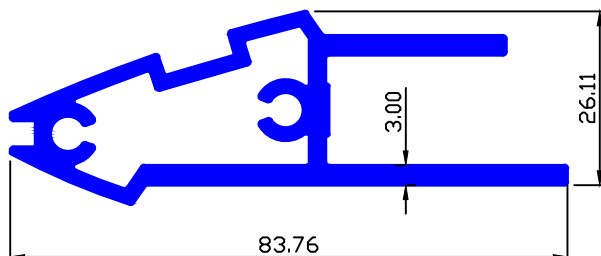

MAAN SEC.-90694

1.289 Kg/Mtr.

